

intelligen[™] / Nitrogen
Generator

INS-100/250

Nitrogen Generator

Installation, Operation, and Instruction Manual



P POTTER
The Symbol of Protection

St. Louis, MO
800-325-3936
www.pottersignal.com

Manual #5403644 - K
11/23



WARRANTY INFORMATION

GENERAL PROVISIONS & LIMITATIONS

Potter Electric Signal Company, LLC (the "Company") warrants to each original purchaser ("Purchaser") of its new products from the Company or its Authorized Distributor that such products are, at the time of delivery to the Purchaser, made with good materials and workmanship. No warranty is made with respect to:

1. Any product, which has been repaired or altered in such a way, in the Companies judgment, as to affect the product adversely.
2. Any product, which has, in the Companies judgment been subjected to negligence, accident, improper storage, improper installation or application.
3. Any product, which has not been operated or maintained in accordance with the recommendations of the Company.
4. Components or accessories manufactured, warranted and serviced by others.
5. Any reconditioned or prior owned product.

Claims for items described in 4 above should be submitted directly to the manufacturer.

WARRANTY PERIOD

The Company's obligation under this Warranty is limited to repair or, at its option, replacing during normal business hours at the designated facility of the Company, any part that in its judgment proved not to be as warranted within the applicable Warranty Period as follows.

COMPONENTS

All non-consumable components are warranted for 12 months from the date of purchase. Consumable are not covered under warranty. The unit must have been installed by either a factory authorized distributor or agent in accordance with the factory recommendations taking into account all other local site conditions not originally noted to the factory. The unit must be operated and maintained in accordance with the Factory recommendations and original design conditions. Failure to provide such proof of the above may void warranty.

LABOR TRANSPORTATION & INSPECTION

The Company will repair or replace any product or part thereof which in the Companies judgment is proved to be not as warranted. Labor costs are not covered under warranty.

All costs of transportation of product, labor or parts claimed not to be as warranted and, of repaired or replaced parts to or from factory shall be borne by purchaser. The Company may require the return of any part claimed not to be as warranted to one of its facilities as designated by the Company, transportation prepaid by Purchaser, to establish a claim under this warranty.

Replacement parts provided under the terms of the warranty are warranted for the remainder of the Warranty Period of the product upon which installed to the same extent as if such parts were original components.

DISCLAIMER

THE FOREGOING WARRANTY IS EXCLUSIVE AND IT IS EXPRESSLY AGREED THAT, EXCEPT AS TO TITLE, THE COMPANY MAKES NO OTHER WARRANTIES, EXPRESSED OR IMPLIED OR STATUTORY, INCLUDING ANY IMPLIED WARRANTY OR MERCHANTABILITY.

THE REMEDY PROVIDED UNDER THIS WARRANTY SHALL BE THE SOLE, EXCLUSIVE AND ONLY REMEDY AVAILABLE TO THE PURCHASER AND IN NO CASE SHALL THE COMPANY BE SUBJECT TO ANY OTHER OBLIGATIONS OR LIABILITIES. UNDER NO CIRCUMSTANCES SHALL THE COMPANY BE LIABLE FOR SPECIAL, INDIRECT, INCIDENTAL OR CONSEQUENTIAL DAMAGES, EXPENSES, LOSSES OR DELAYS HOWSOEVER CAUSED.

No statement, representation, agreement, or understanding, oral or written, made by any agent, distributor, representative or employee of the Company which is not contained in this Warranty will be binding upon the company unless made in writing and executed by an officer of the Company.

This warranty shall not be effective as to any claim which is not presented within 30 days after the date upon which the product is claimed not to have been as warranted. Any action for breach of this warranty must be commenced within one year after the date upon which the cause of action occurred.

Any adjustment made pursuant to this warranty shall not be construed as an admission by the Company that any product was not as warranted.

PROMPT DISPOSITION

The Company will make a good faith effort for prompt correction or other adjustment with respect to any product, which proves to be defective within the warranty period. Before returning any product, write or call the distributor, agent or authorized company from which the product was purchased, describing defect and giving date and number of original invoice, as well as proof of Factory supplied consumable and proof of scheduled maintenance. Title and risk of loss pass to buyer upon delivery to the common carrier.

PRODUCT SUITABILITY

Many States, Localities and Countries have codes and regulations governing sales, construction, installation, and/or use of products for certain purposes, which may vary from those in neighboring areas. While Potter attempts to assure that its products comply with such codes, it cannot guarantee compliance, and cannot be responsible for how the product is installed or used. Before purchase and use of a product, please review the product application, and national and local codes and regulations, and be sure that the product, installation, and use will comply with them.

Potter Electric Signal Company, LLC
St. Louis, MO • (866) 956-0988

CONTENTS

Safety Guidelines	4
Important Notice to Users	4
Unpacking	4
General Safety Information	4
System Overview	6
Key Terms	6
IntelliGen™ Controller	6
INS-100/250 Exterior View	7
INS-100/250 Interior View	8
IntelliGen™ Display	9
Installation of the Nitrogen Generator	10
Wiring of the Nitrogen Generator	14
Nitrogen Generator Operation	16
Nitrogen Functionality Test	18
Filling the Sprinkler System and Purging	19
Purging with IntelliPurge® Nitrogen Purge Valve (INS-PV)	20
Purging with Potter Nitrogen Purge Valve (NGP-SPV)	21
IntelliView™ Dashboard Connectivity	22
IntelliPurge® Wiring and Networking	23
Maintenance and Part Replacements	25
Standard Maintenance (Every 1,000 Compressor Operating Hours)	26
Compressor Air Intake Filters	27
Filter Elements	28
Resetting Maintenance Alert and Checking for Leaks	30
Air Compressor Replacement	31
Nitrogen Membrane Replacement	32
Maintenance Alerts and Actions	32
Trouble Alerts and Probable Causes	33
Troubleshooting	35
Leak on Sprinkler System or Nitrogen Generator	35
Nitrogen Flow Rate and Nitrogen Purity Test	35
Normal Operating Parameters of the INS-100/250	36
Nitrogen Generator Leak Detection System	37
To Change the Leak Rate Warning Set Point	38
To Change Sprinkler System Size	38
INS-100/250 Dimensional Drawings	39
INS-100/250 Piping Instrumentation Diagram	41
Wiring Diagrams	42
INS-100 Single Phase 100-120VAC	42
INS-100 Single Phase 200-240VAC	43
INS-250 Single Phase 115-120VAC	44
INS-250 Single Phase 220-240VAC	45
Menu Trees	46
Menu Tree 1	46
Menu Tree 2	47
Menu Tree 3	48
Menu Tree 4	49
Menu Tree 5	50
Menu Tree 6	51
Menu Tree 7	52

Safety Guidelines



This manual contains safety information that is important to know and understand. This information is provided for the safety of installers, operators, and users of the Potter Nitrogen Generator as well as equipment. To help recognize this information, observe the following symbols.

DANGER

Danger indicates an imminently hazardous situation which, if not avoided, WILL result in death or serious injury.

WARNING

Warning indicates a potentially hazardous situation which, if not avoided, COULD result in death or serious injury.

CAUTION

Caution indicates a potentially hazardous situation which, if not avoided, MAY result in minor or moderate injury

NOTICE

Notice indicates important information, that if not followed may cause damage to equipment or property.

Important Notice to Users

The Installation, Operation, and Instruction Manual supplied with each unit must be read thoroughly and completely understood before installation and operation of the Potter IntelliGen™ Nitrogen Generator. All appropriate safety standards for handling of gases as determined by local or national laws and regulations should be followed at all times.

Unpacking

After unpacking unit, carefully inspect all parts and equipment for any damage that may have occurred during transit. Make sure to tighten fittings, bolts, etc. before putting unit into service.

WARNING

Do not operate if damage occurred during shipping, handling, or use. Contact Potter immediately.

General Safety Information

Important: Read all of the safety information in this manual before operating this equipment. Use of the equipment in a manner not specified within this manual may impair the protection provided by the generator and could result in an unplanned release of pressure, which may cause serious injury or damage. Only competent personnel, who have been trained, qualified, and approved by Potter Electric Signal Company should perform commissioning, servicing, and repair procedures.

When handling, installing, or operating this equipment, personnel must employ safe engineering practices and observe all related local regulations, health, and safety procedures, and legal requirements for safety. Ensure that the equipment is depressurized and electrically isolated, before carrying out any of the scheduled maintenance instructions specified in this manual.

The warnings in this manual cover most known potential hazards, but by definition cannot be all-inclusive. If the user employs an operating procedure, item of equipment, or a method of working that is not specifically recommended by Potter Electric Signal Company, the user must ensure that the equipment will not be damaged or become hazardous to persons or property.

Nitrogen is not a poisonous gas. However, in a concentrated form, there is a risk of asphyxiation. The generator produces a flow of nitrogen and oxygen enriched air which quickly disperses in the atmosphere. However, do not directly inhale the output gas from the outlet pipe.

The generator is classified as non-hazardous for transportation purposes and as non-flammable for fire regulations. This equipment is for indoor use only. Do not operate outdoors.

WARNING

Operation of the nitrogen membrane separator above the rated design pressure may be hazardous. Do not connect it to compressed air sources that can exceed its maximum rated pressure without installing appropriate pressure controls and safety relief devices in the compressed air supply line.

Specific procedure must be developed for maintenance of the equipment on which the membrane separator is located. Appropriate labels must be continuously displayed in all areas where personnel might be exposed to a nitrogen atmosphere under normal or upset condition.

NOTICE

Do not attempt to disassemble the nitrogen membrane separator. Equipment damage may occur and cause the system to function incorrectly.

System Overview

Potter IntelliGen™ Nitrogen Generators are specifically designed to provide clean, dry, high purity nitrogen for use in fire protection sprinkler systems. The generator is a fully assembled package ready to be connected to a new or existing fire sprinkler system using a factory pre-engineered air compressor. These easy-to-use systems include all air filtration equipment and controls required to keep the generator operating at peak efficiency.

The Potter IntelliGen™ Nitrogen Series operates using membrane technology. The smaller oxygen and water vapor molecules can pass through (permeate) the membrane quickly. The larger nitrogen molecules are less likely to diffuse through the separator tubes; therefore, they continue downstream to the separator outlet. The permeated molecules are discharged to the atmosphere through a vent in the separator housing.

Key Terms

Bypass Mode – Most nitrogen generators cannot produce enough nitrogen to completely fill the sprinkler system in 30 minutes required by NFPA 13. Therefore, they contain valves that allow the nitrogen membrane to be bypassed so the system can be filled with compressed air. The valve setting that bypasses the nitrogen membrane is called Bypass Mode.

Nitrogen Generating Mode – The valve setting that allows the air to flow through the nitrogen membrane and create nitrogen is called Nitrogen Generating Mode.

Purging – Purging is defined as the removal of oxygen from the sprinkler system via a purge valve. The purge valve allows some gas to escape from the system which requires the nitrogen generator to supply nitrogen to maintain system pressure. This process therefore increases the nitrogen concentration within the system piping over time.

IntelliGen™ Controller

The IntelliGen™ Nitrogen Generator Series is the only line of intelligent nitrogen generators for fire sprinkler systems. At the heart of the IntelliGen™ units, is the IntelliGen™ Controller. The IntelliGen™ Controller monitors every aspect of the nitrogen generator to ensure the unit is performing optimally. The IntelliGen™ Controller monitors pressure, runtime, power, connectivity and operational mode. Using this information and proprietary algorithms, the IntelliGen™ Controller can determine if the unit needs to be in Bypass Mode or Nitrogen Generating Mode. No need to manually change ball valve configurations or worry if the unit is producing nitrogen. Also, by monitoring the generator activity the controller can indicate the development of sprinkler system leaks, user interaction, and even if maintenance to the generator is required. Combined with the IntelliPurge® Nitrogen Purge Valve, the IntelliGen™ Nitrogen Generator is the only system that can truly monitor and protect a sprinkler system.

See Menu Tree Diagram on page 46 for more information on programming.

- The INS-100 has a Bypass Fill Capacity of 160 gallons at 40 psi and a Total System Capacity of 675 gallons.
- The INS-250 has a Bypass Fill Capacity of 300 gallons at 40 psi and a Total System Capacity of 1,000 gallons.

Part Number	Model	Description
1119650	INS-100,100-120VAC 1PH 60HZ	IntelliGen™ Nitrogen System-100,100-120VAC Single Phase
1119651	INS-100, 200-240VAC 1PH 60HZ	IntelliGen™ Nitrogen System-100,200-240VAC Single Phase
1119604	INS-250,115-120VAC 1PH 60HZ	IntelliGen™ Nitrogen System-250,115-120VAC Single Phase
1119605	INS-250, 220-240VAC 1PH 60HZ	IntelliGen™ Nitrogen System-250,220-240VAC Single Phase

INS-100/250 Exterior View

Fig. 1

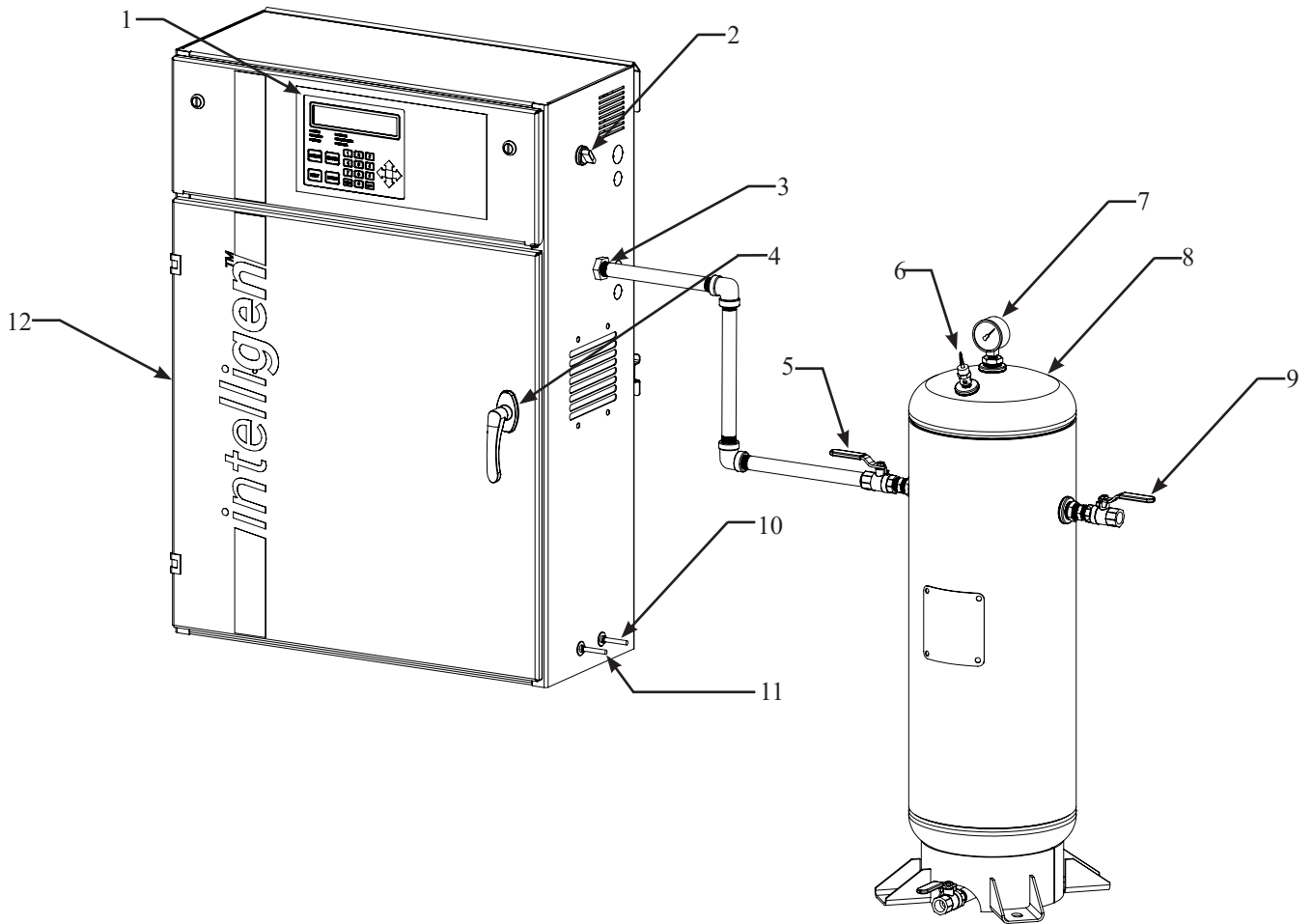

- | | |
|--|---|
| 1. IntelliGen™ Display | 8. Nitrogen Tank |
| 2. Air Compressor Power Switch | 9. 1/2" FNPT N ₂ Tank Outlet Valve (V03) |
| 3. 1/2" FNPT Nitrogen Outlet | 10. Water Separator Drain Outlet 1/4" tubing (10' Supplied) |
| 4. Locking Door Handle | 11. Filter Drain Outlet 1/4" tubing (10' Supplied) |
| 5. 1/2" FNPT N ₂ Tank Inlet Valve (V02) | 12. Nitrogen Cabinet |
| 6. Pressure Relief Valve (140 psi) | |
| 7. Nitrogen Tank Gauge | |

INS-100/250 Interior View (INS-250 Compressor Shown)

Fig. 2

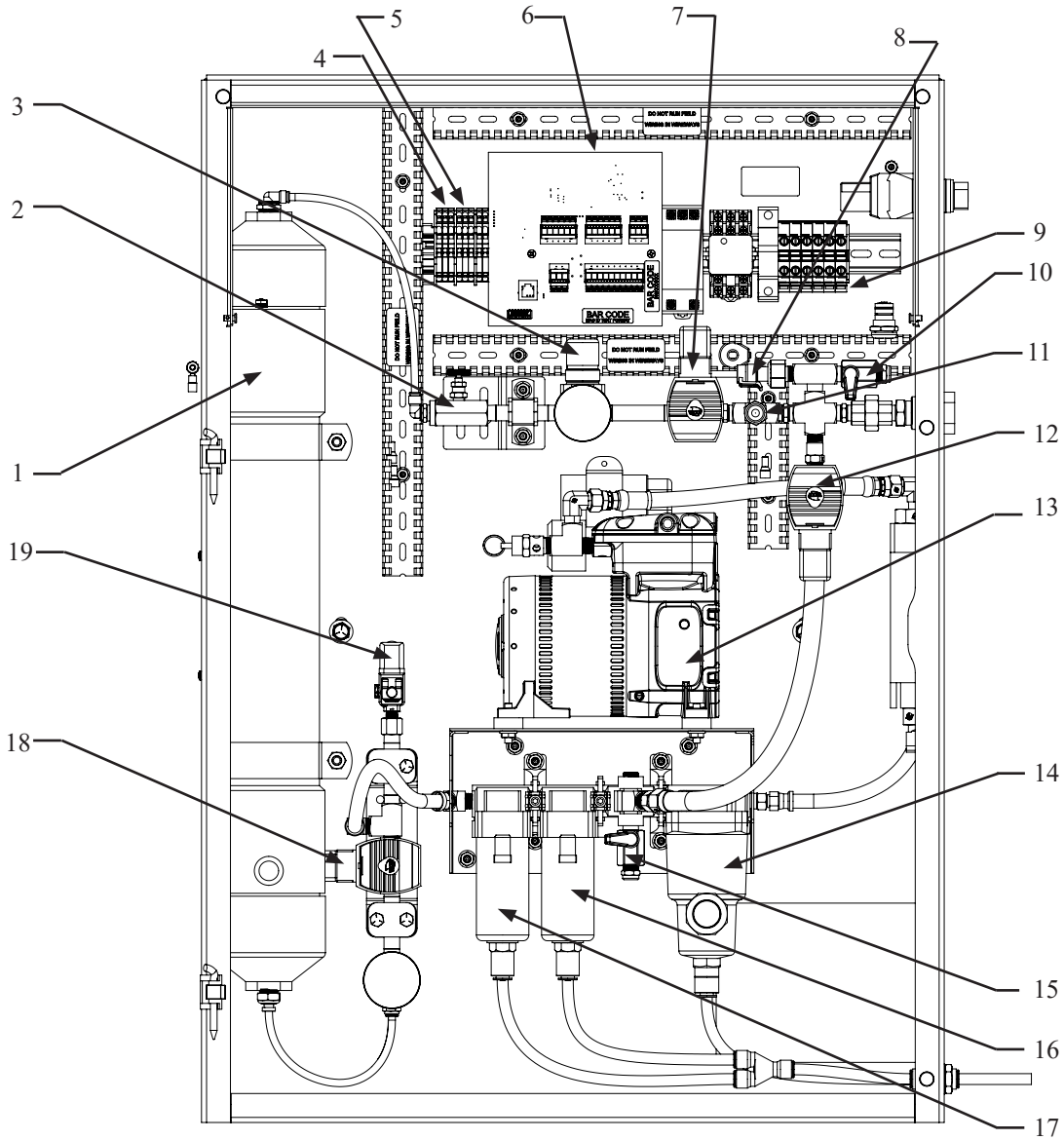

- | | |
|---|--|
| 1. Nitrogen Membrane (M01) | 11. Nitrogen Sample Port (SP) |
| 2. Flow Control Valve (FCV01) | 12. Bypass Solenoid Valve (XV03) |
| 3. Back Pressure Regulator (PRV02) | 13. Air Compressor (CA01) |
| 4. BMS Connection | 14. Water Separator (WS01) |
| 5. PLINK Connection | 15. Air Bleed Valve (V05) |
| 6. IntelliGen™ Controller | 16. Coalescing Filter (F01) Stage 1 |
| 7. Membrane Outlet N ₂ Solenoid (XV02) | 17. Coalescing Filter (F02) Stage 2 |
| 8. Pressure Transducer (PI01) | 18. Membrane Inlet Air Solenoid (XV01) |
| 9. Owner Supplied Power Connection | 19. Compressor Unloader (XV04) |
| 10. N ₂ Bleed Valve (V01) | |

IntelliGen™ Display:

The IntelliGen™ Display is the interface to the IntelliGen™ Nitrogen Generator. This display shows the generator's history, parameters, and troubles; as well as devices networked to the unit.

Fig. 3

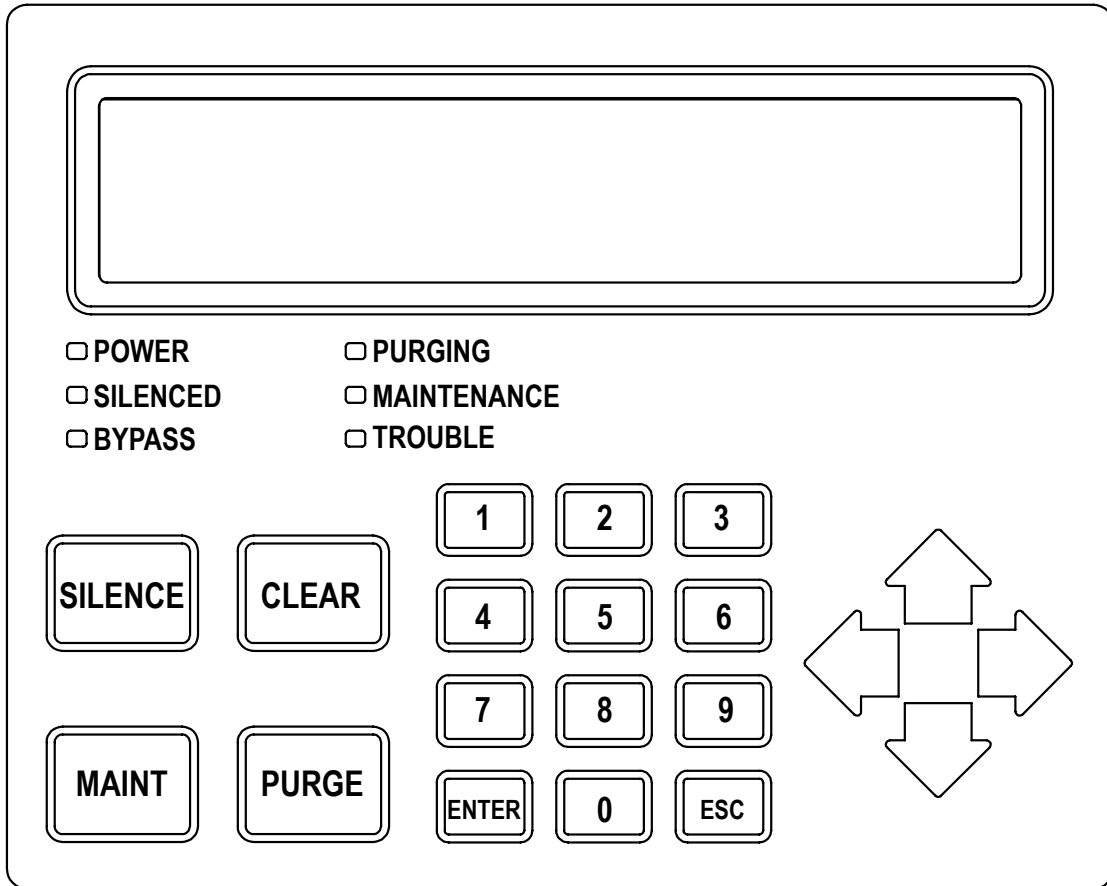
**IntelliGen™ Display LED Light Indications:**

POWER – The green POWER LED indicates if the IntelliGen™ Nitrogen Generator has power.

SILENCED – The amber SILENCED LED indicates the Trouble Horn on the IntelliGen™ Nitrogen Generator is silenced.

BYPASS – The amber BYPASS LED indicates if the IntelliGen™ Nitrogen Generator is in Bypass Mode. If the Bypass LED indicator is off, the unit is in Nitrogen Generating Mode.

PURGING – The amber PURGING LED indicates the IntelliGen™ Nitrogen Generator detects that a networked INS-PV is in a purge process.

MAINTENANCE – The amber MAINTENANCE LED indicates the IntelliGen™ Nitrogen Generator needs maintenance.

TROUBLE – The red TROUBLE LED indicates the IntelliGen™ Nitrogen Generator has a trouble condition.

IntelliGen™ Display Button Indications:

SILENCE – The "SILENCE" button will silence the Trouble Horn on the IntelliGen™ Nitrogen Generator.

CLEAR – The "CLEAR" button will clear all Troubles.

MAINT – The "MAINT" button will display the Maintenance Menu.

PURGE – The "PURGE" button will bring up the Purge Menu on the IntelliGen™ Display.

Installation of the Nitrogen Generator

1. On arrival, do a full inspection by checking all packages and crates in the shipment for damage.
2. If damage is found, sign for the damage or refuse the shipment. Contact the carrier immediately and file a shipping damage claim with the carrier.
3. Check to ensure all components are contained and no visible damage has occurred during shipping.
 - Nitrogen Cabinet
 - IntelliGen™ Display
 - Nitrogen Tank
 - Air Compressor
4. Each nitrogen generator requires a minimum of one Nitrogen Air Maintenance Device (NAMD) and one Nitrogen Purge Valve per sprinkler system. Check to see these components have arrived.
 - Nitrogen Air Maintenance Device (one per riser) (NAMD #1119660)
 - Nitrogen Purge Valve (NGP-SPV #1119784) or (INS-PV #1119478)
 - Portable Nitrogen Analyzer (one per job) (PNA #1119504)
5. Find a location for the nitrogen generator to be installed meeting these requirements:
 - Dry, clean and well-ventilated
 - Cabinet Dimensions: 36" X 26" X 12" (H x W x D) - Weight: 130 lbs.
Tank Dimensions: 36" X 18" X 10" (H x W x Ø) - Weight: 45 lbs.
 - Allow 3 inches of space on either side of cabinet for piping and airflow
 - Ambient temperatures above 50° F at all times
 - Access to front for service
 - Conveniently located near fire sprinkler system connections
 - Conveniently located near a drain
 - Near a dedicated electrical circuit with an electrical disconnect switch
6. If mounting to the floor, anchor the Nitrogen cabinet using (4) 5/16" flanged bolts. See Fig. 4.

Fig. 4

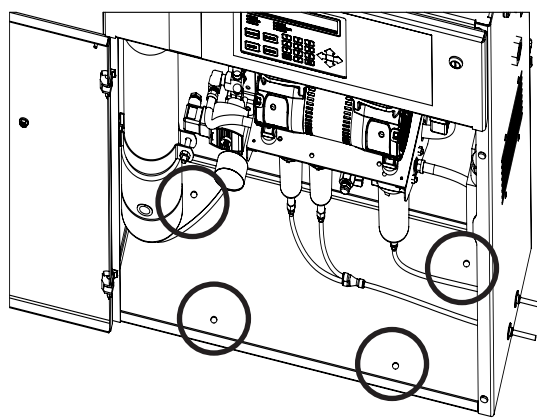

7. If wall mounting, remove wall mount bracket from the back of the cabinet. (2) 3/8" bolts will need to be unscrewed from the inside of the cabinet. Retain the two bolts. See Fig. 5.

Fig. 5

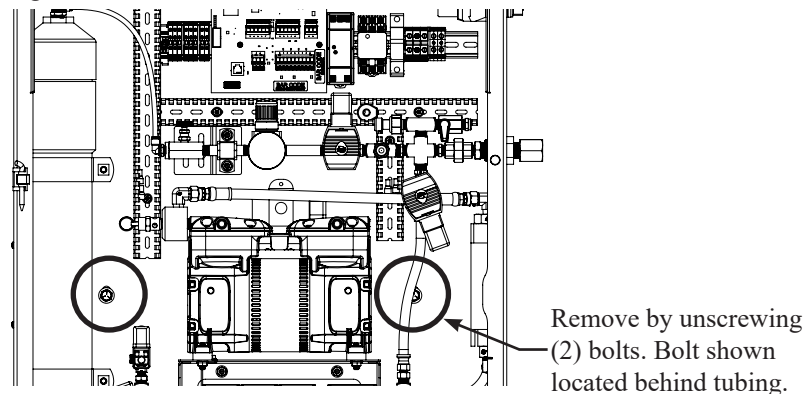

8. Mount wall bracket to studs in the wall using (4) $\text{\O} 5/16''$ lag bolts or appropriate wall anchors. See Fig. 6.

⚠ CAUTION

Nitrogen cabinet weighs 130 lbs. Ensure wall and anchors can support the unit.

Back of INS-100/250

Fig. 6

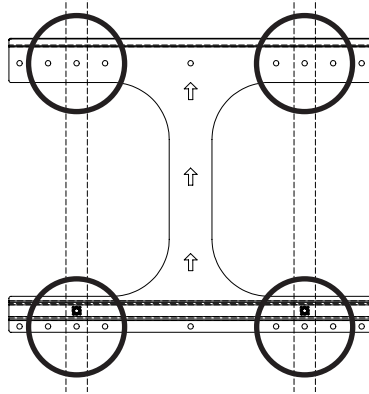

9. Lift the nitrogen cabinet onto the wall bracket. See Fig. 7.

Fig. 7

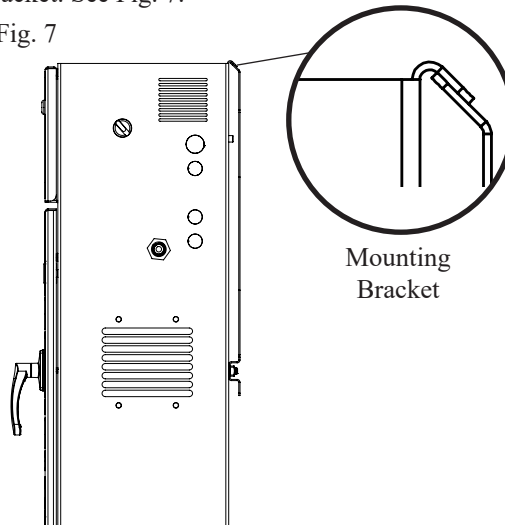

10. Bolt the nitrogen cabinet to the wall bracket using the (2) $3/8''$ bolts removed in step 7. See Fig. 8.

Fig. 8

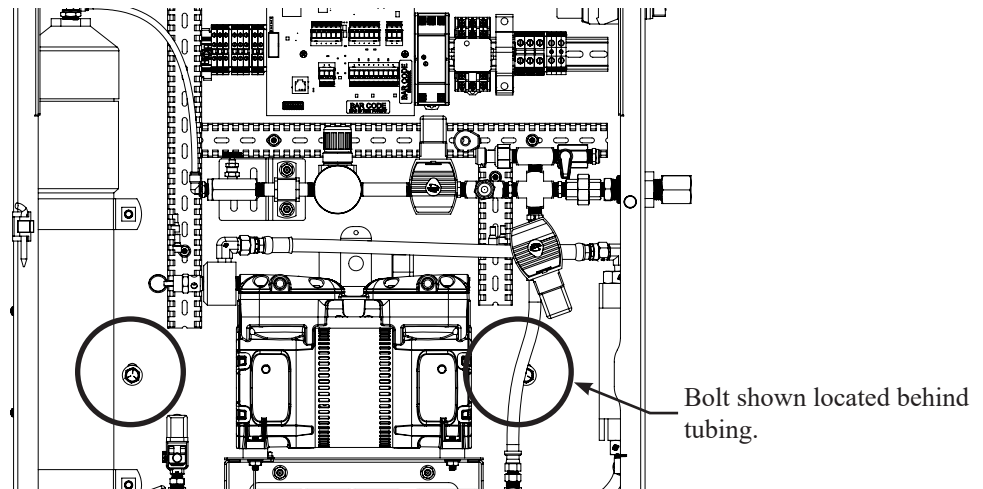

11. Anchor the nitrogen tank to the floor using (4) Ø 3/8" flanged bolts. See Fig 9.

Fig. 9

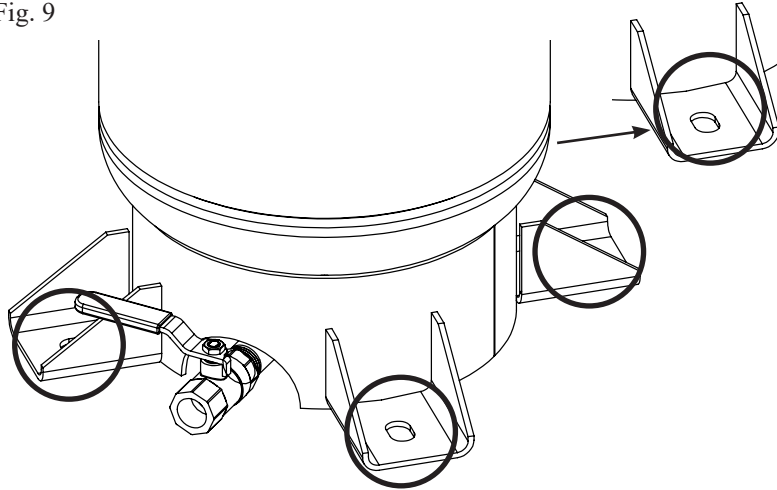

12. Install ½" NPT piping from the nitrogen outlet connection **A** on the nitrogen cabinet to the nitrogen inlet connection **A** on the nitrogen tank. See Fig. 10.

Fig. 10

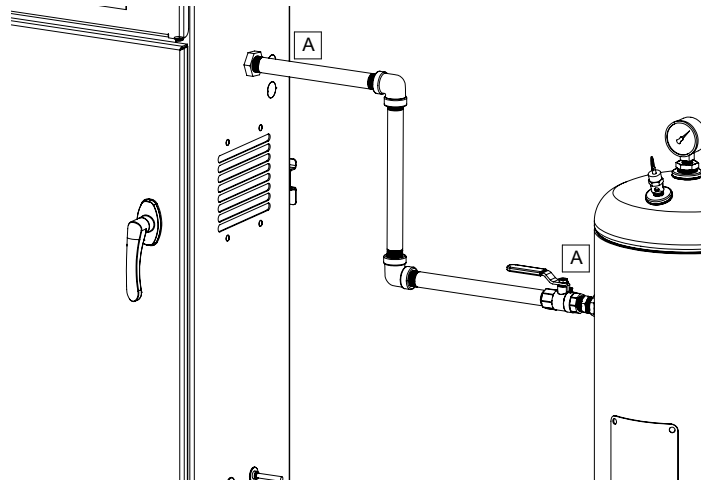

13. Install ½" NPT piping from the ½" FNPT Tank Outlet Valve (V03) on the nitrogen tank to the Nitrogen Air Maintenance Device. See Fig. 11.

Fig. 11

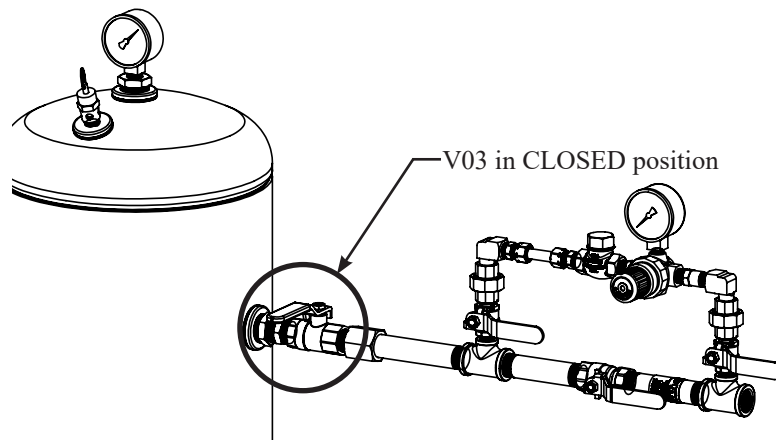

14. Plumb the Nitrogen Air Maintenance Device to the fire sprinkler system.

15. Insert the provided (2) 10' of the 3/8" drain tubing into the two push to connect fittings and plumb to the floor drain in the sprinkler room. Do not pipe the drain tubing upward. See Fig. 12.

⚠ CAUTION

Ensure drain tubing is restrained. Tubing will occasionally see system pressure when draining.

Fig. 12

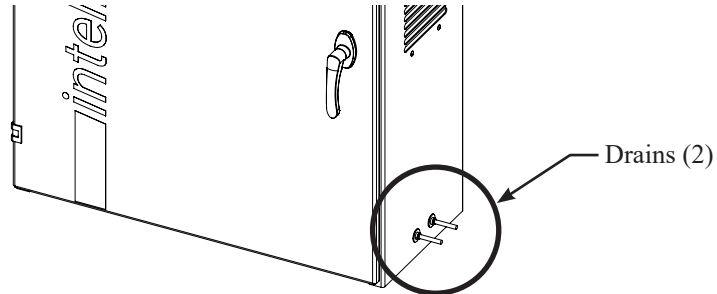

16. Each riser requires a minimum of one (1) Nitrogen Purge Valve to be installed prior to commissioning the system. For installation instructions, refer to Model NGP-SPV Bulletin (#5401520) or Model INS-PV Manual (#5401532) supplied with each purge valve. See Fig. 13 for NGP-SPV installation diagram. See Fig. 14 for INS-PV installation diagram.

Fig. 13

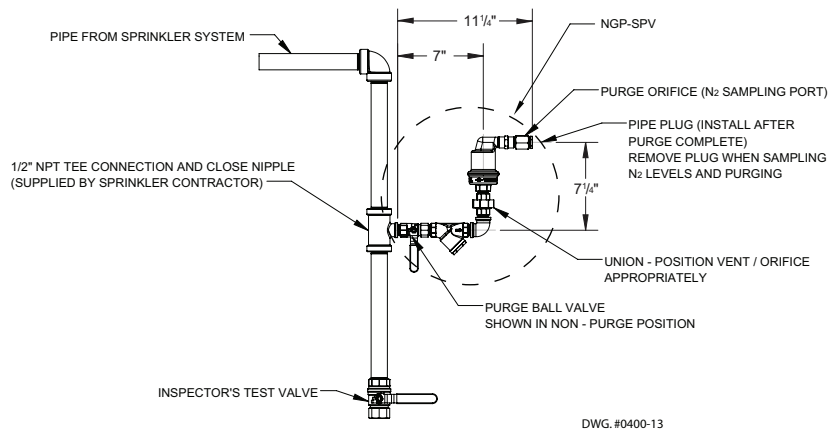
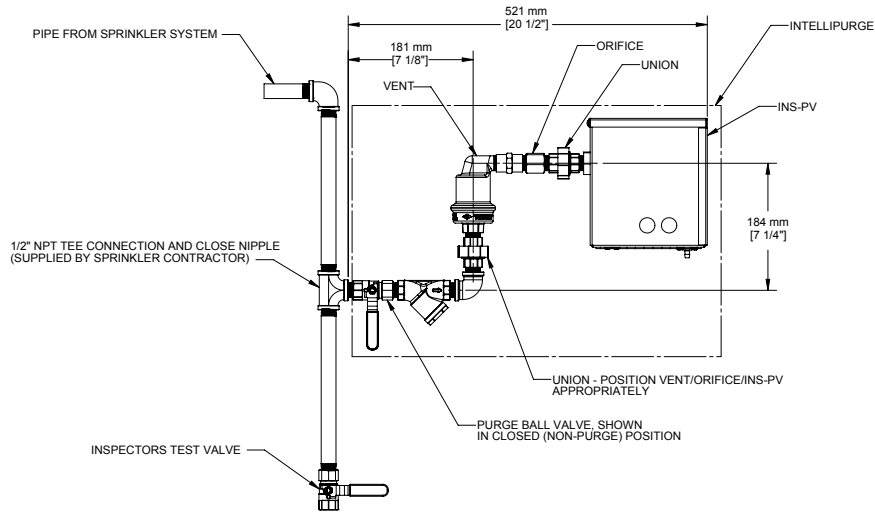

Fig. 14



NOTICE

Installing the purge valve upside down will not allow the system to purge. Also, ensure that there is NO water in the pipe to the purge valve.

Wiring of the Nitrogen Generator

NOTICE

All wiring should be performed by a licensed electrician and conform to NEC and all applicable local standards.

1. Run a dedicated electrical circuit with an electrical disconnect switch to sprinkler room.
2. To wire the INS-100/250, open the front panel at the top of the nitrogen cabinet to access wiring terminal blocks. Use the 1/2" or 3/4" knockouts on the right side of the cabinet for electrical conduit. See Fig. 15.

Fig. 15

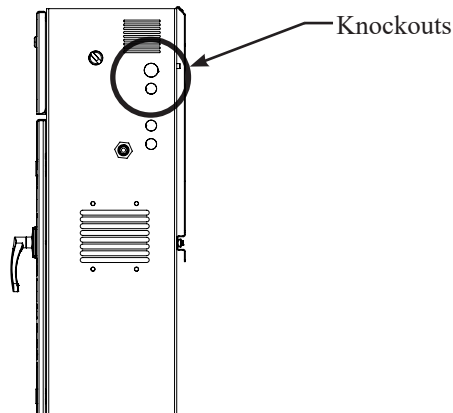

3. Depending on the voltage of the model follow the wiring diagram in this manual on pages 42-45, or use the wiring diagram on the inside of the nitrogen generator cabinet door.

Fig. 16

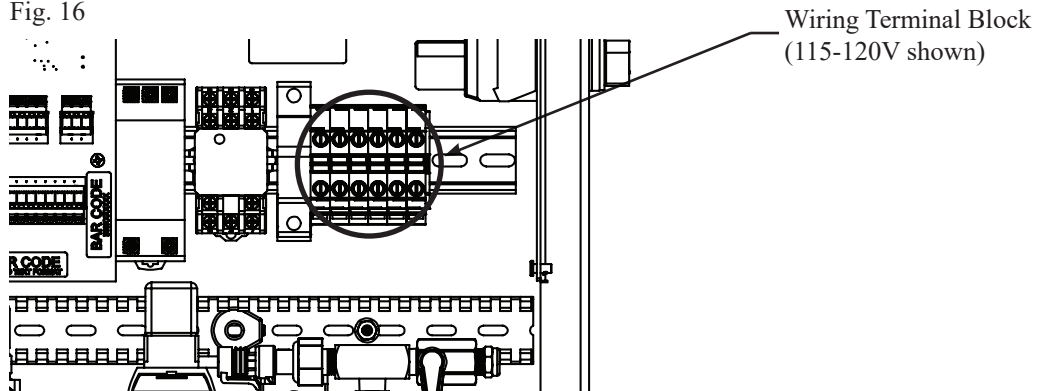

4. For internet connectivity (see the IntelliView™ section on page 22 for more details), wire a CAT-5 Ethernet cable using a 1/2" or 3/4" knockout on the left side of the cabinet to the Ethernet Port on the IntelliGen™ Controller. See Fig. 17 and Fig. 18.

Fig. 17

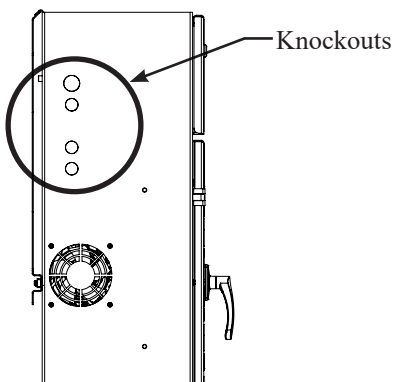
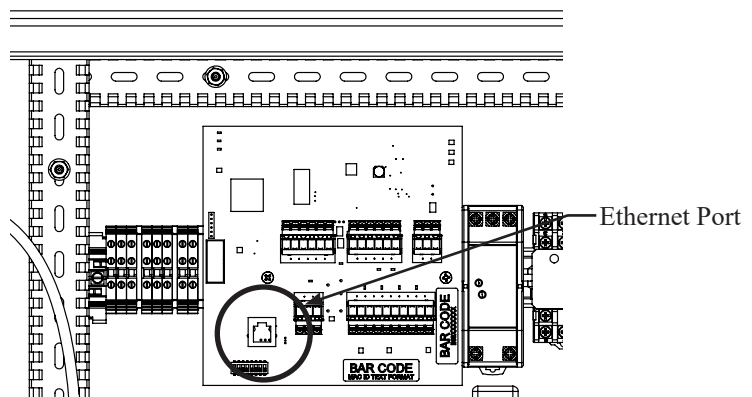
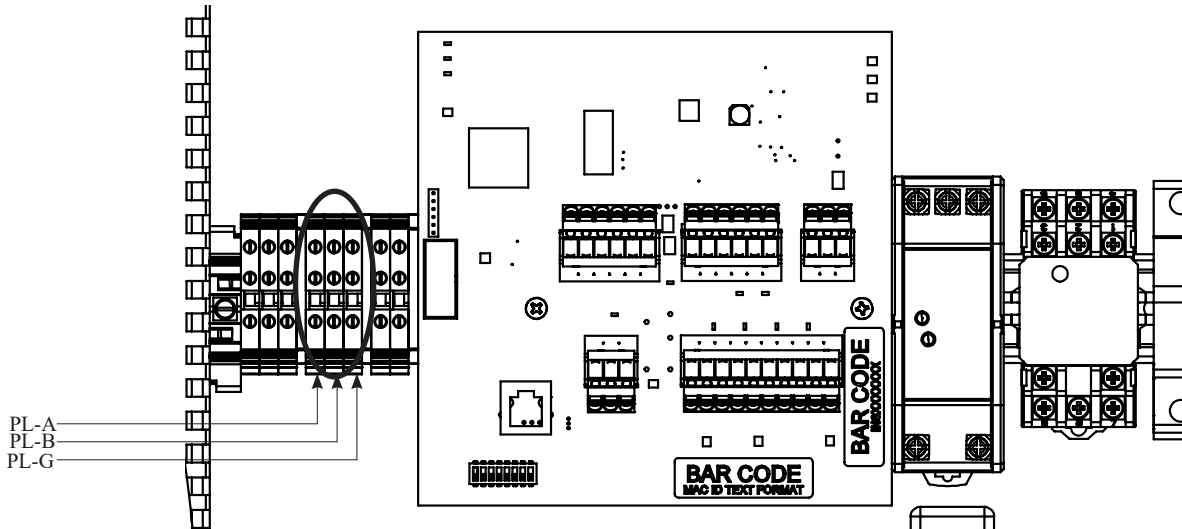

Fig. 18



- Using a 1/2" or 3/4" knockout on the left side of the cabinet, wire the IntelliPurge® Nitrogen Purge Valve to the IntelliGen™ Controller using twisted pair 3 wire cable (22-24 AWG stranded recommended). See the IntelliPurge® Section on page 23 for more details. Connect the PLINK to the terminal blocks next to the controller. See Fig. 19.

Fig. 19



- Using a 1/2" or 3/4" knockout on the left side of the cabinet, a form C relay is available to wire any BMS (Building Management System) to the BMS terminal blocks. See Fig. 20.

Fig. 20

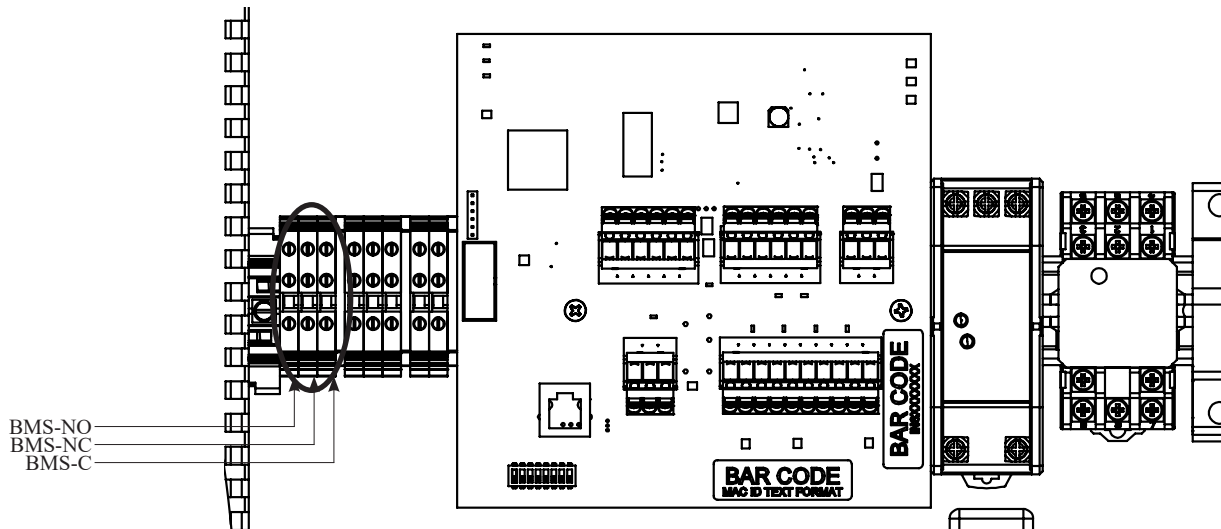

Nitrogen Generator Operation

Initial Set Up:

1. Before beginning, make sure the water supply to the sprinkler system is turned off.
2. Make sure all piping connections have been made in accordance with the installation instructions.
3. Ensure the Air Compressor Power Switch located on the right side of the cabinet is in the "OFF" position.
4. Close the Nitrogen Air Maintenance Device. If multiple Nitrogen Air Maintenance Devices are used, ensure all valves are in closed position.
5. Close the N₂ Tank Outlet Valve (V03) on the nitrogen tank.
6. Open N₂ Inlet Valve (V02) on the nitrogen tank. See Fig. 21.

Fig. 21

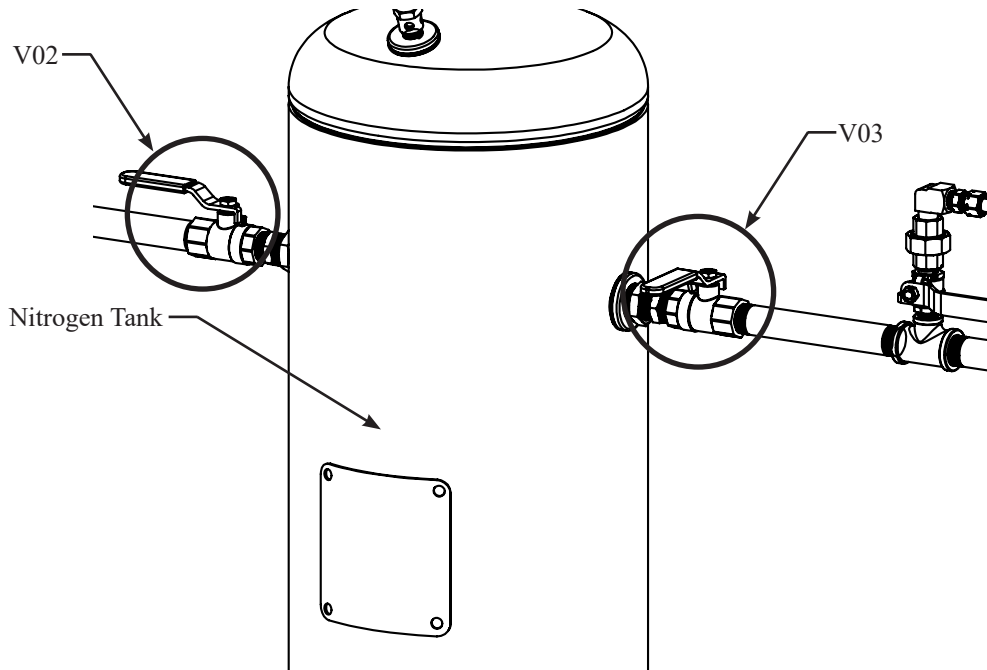

7. Turn power ON to the nitrogen generator using the contractor installed "Electrical Disconnect" switch.
 8. The IntelliGen™ Display will turn on, indicating power with a green LED labeled "POWER".
- Note:** There will be a short delay as the IntelliGen™ Display turns on and the system boots up.
9. The amber LED labeled "BYPASS" will activate if the pressure is less than 55 psi in the nitrogen tank.

10. Turn power ON to the air compressor using the switch labeled “Air Compressor Power” on the right side of the cabinet. See Fig. 22.

Fig. 22

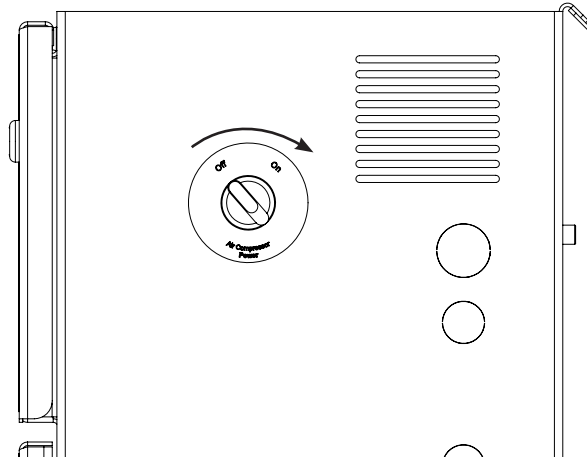

11. The air compressor will begin running and the pressure in the nitrogen tank will begin to rise. Start recording the time it takes until the compressor turns off.
12. When the nitrogen tank pressure reaches approximately 80 psi the valves inside the cabinet will close and the air compressor will turn off.
13. If the nitrogen generator is isolated from the sprinkler system:
- The air compressor of the INS-100 should take no longer than 6 minutes to pressurize the tank and turn off in "BYPASS" mode.
 - The air compressor of the INS-250 should take no longer than 4 minutes to pressurize the tank and turn off in "BYPASS" mode.

If the air compressor is not turning off, or it is taking longer than expected, go to the Troubleshooting section in this manual on page 33.

14. When the nitrogen tank is pressurized, the amber LED labeled "BYPASS" on the IntelliGen™ Display will turn off and "Mode" on the IntelliGen™ Display will change to "N2 Mode". This indicates that the unit is now in Nitrogen Generating Mode.
15. Check all piping connections for leaks as pre-plumbed fittings may have loosened during shipment. Any pressure drop on the nitrogen tank during this time could indicate a leak.

Nitrogen Functionality Test:

1. To ensure the nitrogen generator is operating correctly and that the correct nitrogen purity is being produced, a functional test must be performed.
2. On the inside of the nitrogen cabinet locate the blue N₂ Bleed Valve (V01). See Fig 23.

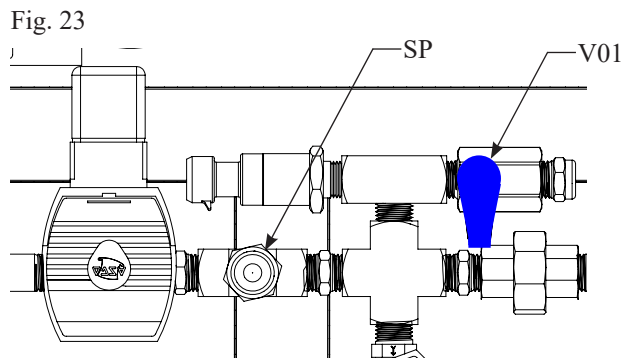

3. Slightly open the blue N₂ Bleed Valve and begin relieving the pressure from the nitrogen tank.
4. Quickly close the blue N₂ Bleed Valve when you see the red LED on the compressor unloader (XV04) turn on. This will happen at approximately 60 psi as shown on the IntelliGen™ display. See Fig. 24.

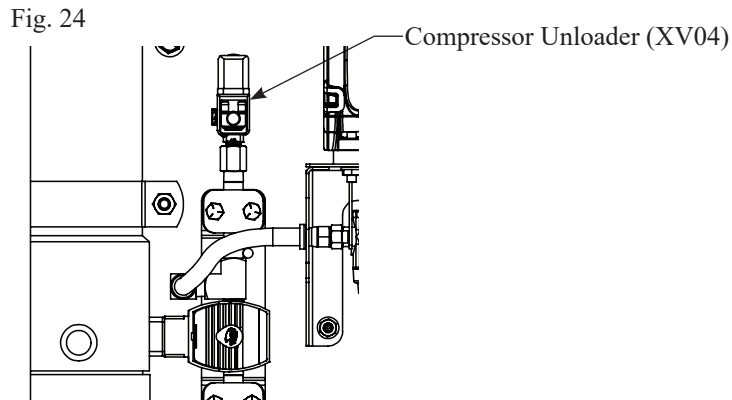

Note: If the pressure in the nitrogen tank drops below 55 psi, the IntelliGen™ Nitrogen Generator will return to Bypass Mode. Close the valve and wait for the nitrogen generator to refill the tanks and the unit to return to N2 Mode before trying again.

5. Immediately begin timing to see how long it takes to reach approximately 80 psi in the nitrogen tank while the nitrogen generator is in N2 Mode.
6. If the nitrogen generator is isolated from the sprinkler system:
 - The air compressor of the INS-100 should take no longer than 8 minutes to pressurize the nitrogen tank to 80 psi.
 - The air compressor of the INS-250 should take no longer than 5 minutes to pressurize the nitrogen tank to 80 psi.
7. During this time, connect the Portable Nitrogen Analyzer to the Nitrogen Sample Port (SP) to measure the purity of the exiting gas. The analyzer should read 98.0% +/- 1%. This may take a few minutes.
8. When the nitrogen generator reaches approximately 80 psi in the nitrogen tank, the air compressor will turn off.

Filling the Sprinkler System and Purging:

1. To fill the sprinkler system, open the N₂ Tank Outlet Valve (V03) on the nitrogen tank and open the bypass valve on the Nitrogen Air Maintenance Device. See Fig. 25.

Fig. 25

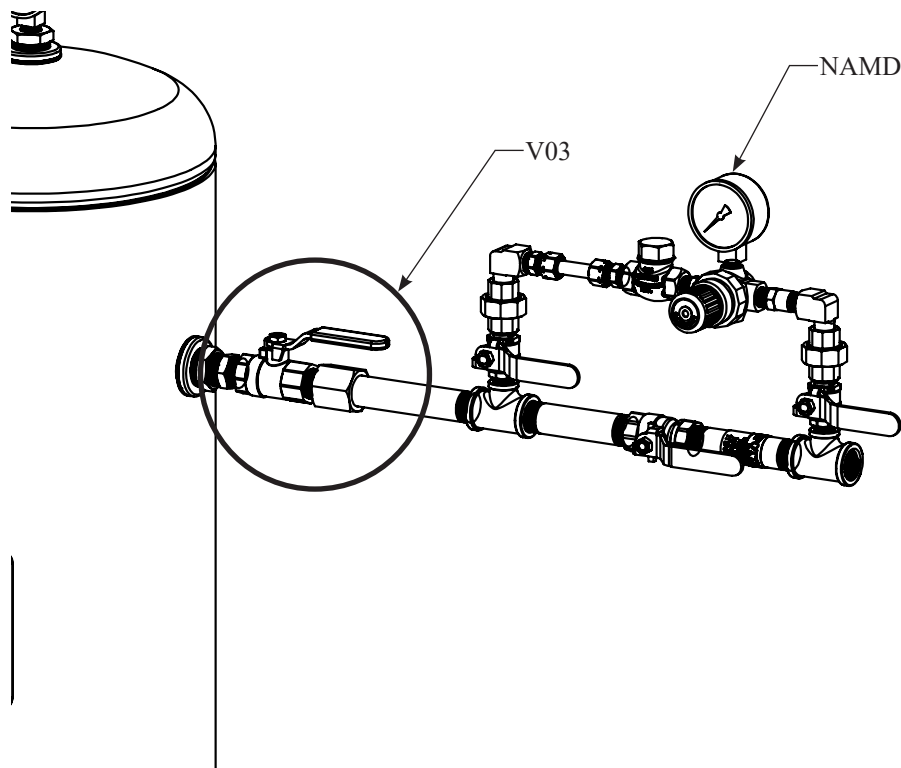

2. The pressure in the nitrogen tank will decrease rapidly, causing the nitrogen generator to switch to Bypass Mode and the air compressor to turn on.
3. The amber LED labeled "BYPASS" will turn on and the "Mode" on the IntelliGen™ Display will turn to "Bypass Mode". This indicates that the nitrogen generator is filling the system with air to meet the NFPA required 30 minute fill time.
4. Allow the fire sprinkler system to reach the desired pressure. This should take 30 minutes or less.
5. As soon as sprinkler system supervisory pressure is reached, put the sprinkler system back into service by placing the Nitrogen Air Maintenance Device in the maintenance position (refer to the Nitrogen Air Maintenance Device manual for proper operation).

NOTICE

Fill only one fire sprinkler system at time. Doing multiple systems at once could lead to longer compressor runtimes and possible damage to equipment. Allow air compressor to cool before beginning again.

6. When the sprinkler system(s) are completely filled, the nitrogen generator will repressurize the nitrogen tank to capacity. The air compressor will turn off and the unit will automatically return to Nitrogen Generating Mode.

Note: The amber LED labeled "BYPASS" should be off and the "Mode" on the IntelliGen™ Display will display "N2 Mode".
7. Reset the Leak Rate by pressing the "MAINT" button on the IntelliGen™ Display Keypad. Enter "0000" for passcode.
8. Move the cursor to "Excess N2 Demand" and press "ENTER".
9. Press "ENTER" on the keypad to clear maintenance alert and reset Leak Rate (LR).
10. You will receive confirmation that the alert has been cleared.
11. Press "ESC" to return to the main screen.

Purging with IntelliPurge® Nitrogen Purge Valve (INS-PV):

Fig. 26

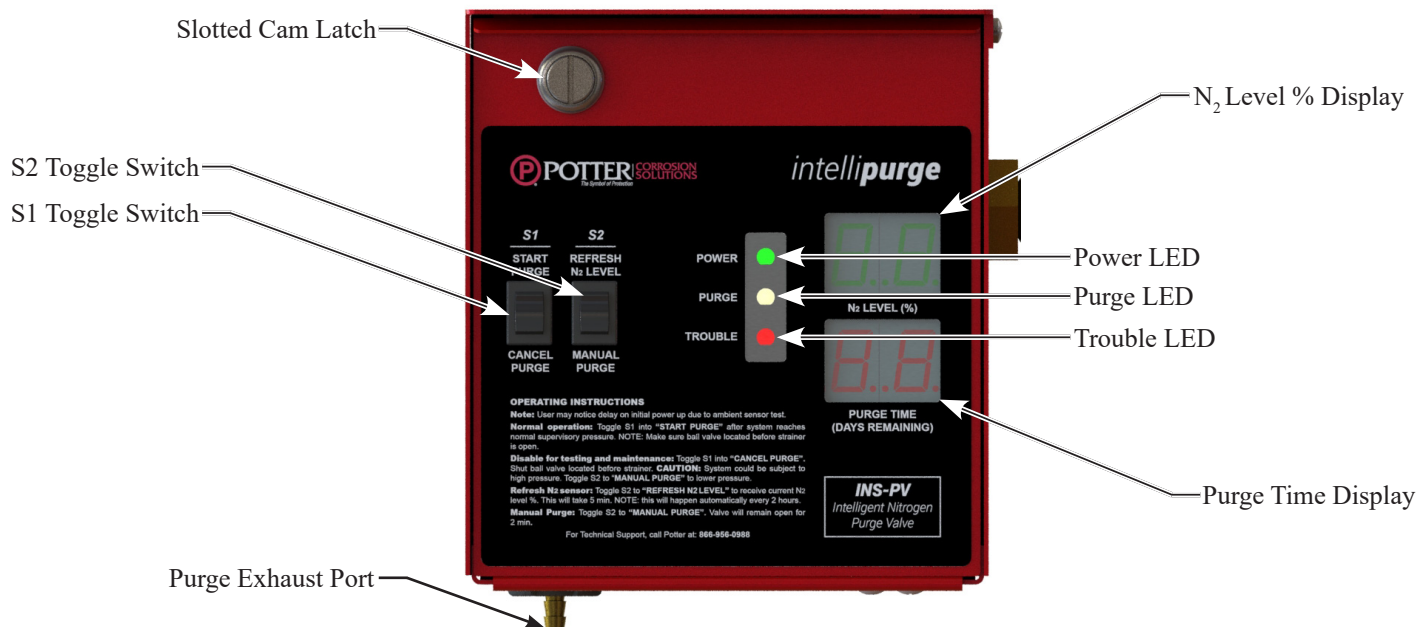

1. See Manual #5401532 for full details on installing, programming, purging and wiring of the INS-PV.
2. Go to the end of the sprinkler system(s) where the INS-PV(s) is installed. Each riser should have one INS-PV.
3. Check to ensure power is connected to the INS-PV. The green Power LED will be ON.
4. Open the ball valve on the INS-PV.
5. Ensure the INS-PV is installed properly. Installing the valve upside down will cause the unit to not purge. Any trapped water in the piping will also cause the unit to not purge.
6. To check that the INS-PV is allowing air/nitrogen flow, toggle the “MANUAL PURGE” switch ON. This will open the solenoid valves inside the unit.
7. If the sprinkler system is pressurized, listen for flow out of the Purge Exhaust Port on the bottom of the unit. You may also use your fingers to feel for flow. If no flow is present, there is a blockage such as a closed ball valve, water in the pipe, or a clogged orifice upstream.
8. If the INS-PV unit is not connected to a nitrogen generator or an INS-RA, toggle the “START PURGE” switch to start the Purge Process.
9. Once the Purge Process has started, the yellow Purge LED indicator will begin blinking.
10. The Purge Time Display will display the max number of purge days, which is the maximum amount of time the unit is allowed to purge before indicating a trouble.
11. The INS-PV is now purging. The oxygenated air is escaping out of the Purge Exhaust Port.
12. If an IntelliPurge® Nitrogen Purge Valve (INS-PV) is connected to a nitrogen generator or an INS-RA, the S1 toggle switch will be DISABLED.
13. Return to the nitrogen generator.
14. If an INS-PV is connect to the nitrogen generator, and you have "Learned Network", press the “PURGE” button on the IntelliGen™ Display keypad.
15. Follow all prompts.
16. Once the system reaches 98% the INS-PV automatically closes and your system is purged.

Purging with Potter Nitrogen Purge Valve (NGP-SPV):

Fig. 27



1. See Bulletin #5401520 for full details on installing and purging of the NGP-SPV.
2. Go to the end of the sprinkler system(s) where the NGP-SPV(s) is installed. Each riser should have one NGP-SPV purge valve.
3. Ensure the NGP-SPV is installed properly. Installing the valve upside down will cause the unit not to purge. Any trapped water in the piping will also cause the unit not to purge. Open the ball valve on the NGP-SPV.
4. Open the ball valve on the NGP-SPV.
5. Unscrew the 1/2" pipe plug located at the end of the NGP-SPV.
6. Check to ensure flow is coming out the purge valve.
7. If the sprinkler system is pressurized, listen for flow. You may also use your fingers to feel for flow. If no flow is present, there is a blockage such as a shut ball valve, water in the pipe, or a clogged orifice upstream.
8. Wait approximately 14 days before returning to the job site and checking the exiting gas with the Portable Nitrogen Analyzer.
9. Check the nitrogen purity to ensure the exiting gas is 98% or greater.
10. If the gas is 98% purity or greater close the ball valve and screw the plug back in. The system is purged.
11. If the nitrogen purity is 85% or greater, wait another 7 days before returning to the site and rechecking. Some larger systems may have longer purge times.
12. If the nitrogen purity is around 80% it indicates that there is a blockage in the sprinkler system piping, the ball valve is closed on the purge valve or that your nitrogen generator is in Bypass Mode.

IntelliView™ Dashboard Internet Connectivity

Potter's IntelliGen™ Controller is designed to provide you with live status updates of your nitrogen generator. The IntelliGen™ Nitrogen Generator needs to be wired using a Cat 5 Ethernet cable. The Ethernet port is located on the bottom left of the IntelliGen™ Controller. When the unit is wired and powered on, data will be accessible at www.PotterIntelliView.com.

Register your nitrogen generator, visit www.PotterIntelliView.com.

1. Log In or Register New User.
2. If you are a new user you will be required to enter your name, company information, and a valid e-mail address.
3. You will receive an e-mail confirmation with an account verification link.
4. Once logged in, click the "Register Generator" button on the Dashboard Overview page.
5. Enter the unit's MAC ID Number and the Serial Number which can be found on the IntelliGen™ Controller inside the cabinet. See Fig. 28.

Fig. 28

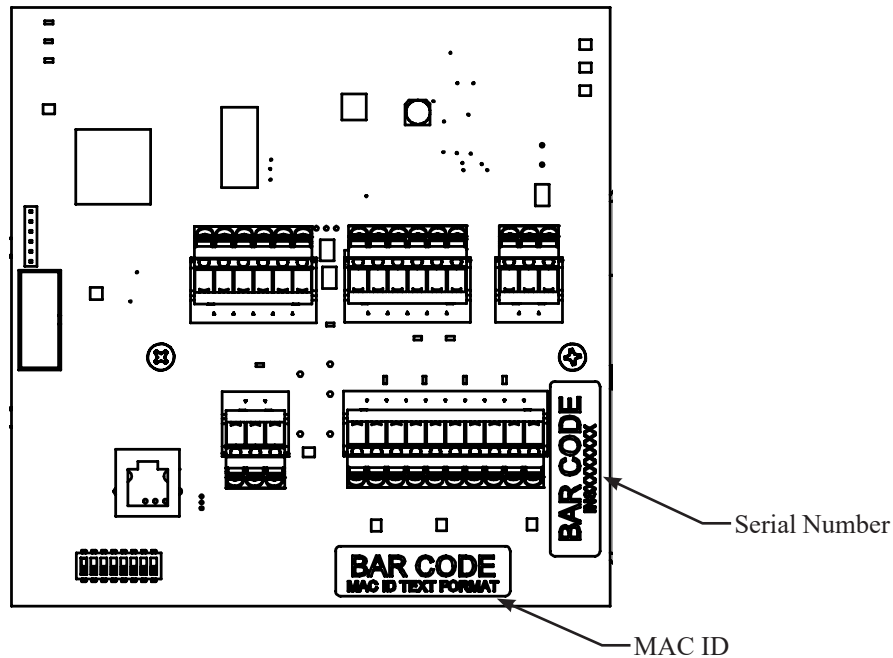

6. Add a name for the generator and the building where the generator is located.
7. A window will appear indicating that you have successfully added the nitrogen generator. Click save.
8. The page will refresh with information on the new nitrogen generator.
9. For more information on the Potter IntelliView™ Dashboard, watch a tutorial at www.potterintelliview.com.

IntelliPurge® Wiring and Networking

1. The PLINK network is Potter’s propriety networking connection. It is a RS-485 network for serial communication between the Nitrogen Generator (INS Series) and its Purge Valves (INS-PV).
2. PLINK requires 3 signal lines to allow communication to and from the Nitrogen Generator and the Purge Valves.
 - PL-A
 - PL-B
 - PL-G

Recommended Cat 5 Stranded Cable

Fig. 29

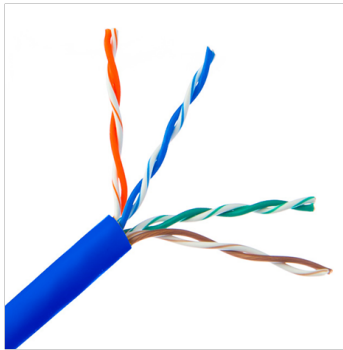

The other 5 wires are not needed in this application. Cut unused wires.

3. The PLINK network must use stranded, twisted pair wire for PL-A and PL-B. We recommend Cat 5 cable with the unused wires trimmed. It is acceptable to use a single twisted pair cable for PL-A and PL-B with the drain wire being used for PL-G. Do not connect any shield to the drain wire.
4. Maximum number of INS-PV devices networked to an IntelliGen Series Nitrogen Generator is 26. The maximum wire length for the network is 4000 ft.
5. The PLINK network works as a Master and Slave network. The INS generator is defined as the Master.

PLINK Wiring Schematic

Fig. 30

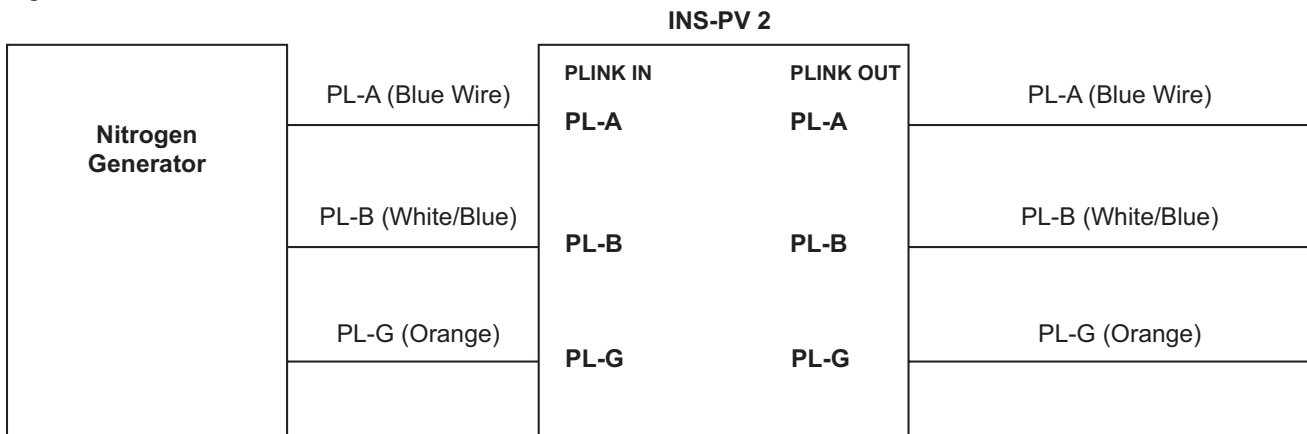

NOTICE

The first INS-PV in the network when connected to the nitrogen generator should be addressed INS-PV-2. The last INS-PV in the network must be addressed as INS-PV-27. If only one (1) INS-PV is networked to the generator it must be addressed as INS-PV-27

- The INS-PV requires 35 watts of 24V AC/DC power. This must be supplied by a dedicated power supply. An optional 120V (40VA) transformer may have been supplied.

PLINK Wiring Diagram

Fig. 31

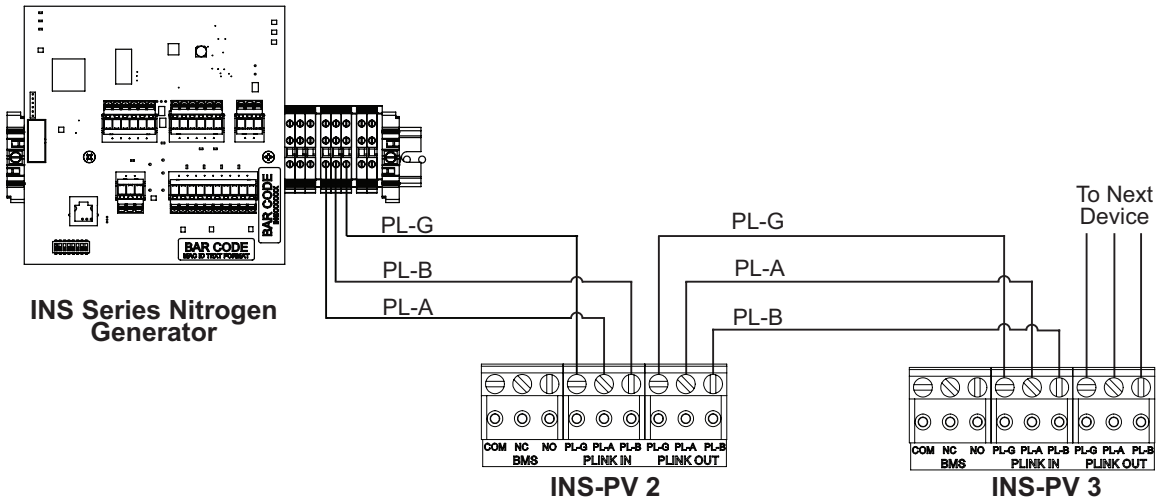

NOTES:

- Wiring from the INS Series Nitrogen Generator to the INS-PVs is low voltage.
 - Do not route INS-PV wiring into the high voltage wire ways.
 - Do not run INS-PV communication or power wiring parallel to any high voltage wiring or conduit. Keep as much space from high voltage wiring as possible. Only cross high voltage wiring with INS-PV wiring at right angles.
 - Do not coil or store excess cable in the INS-PV Cabinet. Doing so may cause communication errors or faulty readings.
- Each INS-PV device comes with a Building Management System (BMS) connection that is a NC or NO contact. This can be wired back to a Building Management System or Fire Panel. If connected to a fire panel it should be wired as a Trouble.

Maintenance and Part Replacements

Potter IntelliGen™ Nitrogen Generators are designed to provide maintenance alerts that ensure the long life of the nitrogen generator. These alerts also ensure that the unit runs at peak efficiency. The IntelliGen™ Nitrogen Generator has an internal maintenance timer that monitors how long the unit has been operating since it has been serviced. Normal scheduled maintenance should be done every 1,000 compressor operating hours, or during the annual inspection of the unit, whichever comes first.

When the system needs maintenance, the amber maintenance light on the IntelliGen™ Display will turn on. If connected to the internet, you will receive an e-mail notification as well. If maintenance on the nitrogen generator is not done within 250 compressor operating hours, the nitrogen generator will show a trouble condition.

To reset the maintenance timer and get the maintenance alert to reset, go to the IntelliGen™ Display.

1. Press "MAINT" on the IntelliGen™ Display keypad.
2. Enter passcode "0000".
3. Select "Std. Maintenance" and press "ENTER".
4. The menu will then display the count down hour log on the Maintenance Timer. Press "ENTER" on the keypad to clear Maintenance Timer. Press "ENTER" to confirm.
5. The amber Maintenance LED will turn off.

CAUTION

All pressure must be relieved from the entire nitrogen generator system BEFORE servicing. To avoid system damage and/or personal injury, the nitrogen generator should be isolated from the sprinkler system and the generator system fully depressurized before any maintenance or service is performed. All maintenance and troubleshooting activities for the Potter Nitrogen Generator should be performed by qualified personnel using reasonable care. Before servicing, isolate all risers by closing all Nitrogen Air Maintenance Device valves and relieving all pressure from the Potter Nitrogen Generator. Failure to do so could result in serious injury or death. Ensure power is turned off at the electrical disconnect.

Scheduled Maintenance - 1,000 Compressor Operating Hours:

- Replace the activated carbon and coalescing filter elements.
- Clean or replace the air compressor intake filter elements.

Annual Inspection:

- Check for unusual noise or vibration.
- Clean all external parts of the compressor and motor.
- Manually test safety relief valves.
- Inspect system for leaks.
- Tighten fittings, nuts and screws as required.
- Check the pressure settings.
- Check the nitrogen purity using Portable Nitrogen Analyzer. It should be 98.0% +/-1%.

Maintenance and Replacement Parts:

Part Number	Description
0090263	KIT-FILTER ELEMENT REPLACEMENT INS-100/250/600
1119504	PORTABLE NITROGEN ANALYZER
1119588	MEMBRANE SEPARATOR-INS-100/250
1119653	COMPRESSOR-1/4 HP, 100-120VAC/200-240VAC 1PH 60HZ / 50HZ (INS-100)
1119595	COMPRESSOR-1/2 HP, 115-120VAC/230-240VAC 1PH 60HZ / 220-240VAC 1PH 50HZ (INS-250)
5230024	AIR INTAKE FILTER (INS-100/250)

Standard Maintenance (Every 1,000 Compressor Operating Hours)

Tools Needed:

- Adjustable wrench
- Rag
- Kit-Filter Element Replacement (INS-100/250/600) (#0090263)
- Air Intake Filter (INS-100/250) (#5230024)

⚠ WARNING

Relieve all pressure from the nitrogen generator before proceeding and turn off power to unit at the contractor installed electrical disconnect.

1. Power off the air compressor using the Air Compressor Power Switch located on the right side of the cabinet.
2. Power off the nitrogen generator using the customer installed electrical disconnect.
3. Isolate the nitrogen generator from the sprinkler system by closing the N₂ Tank Outlet Valve (V03) located on the nitrogen tank. See Fig. 32.

Fig. 32

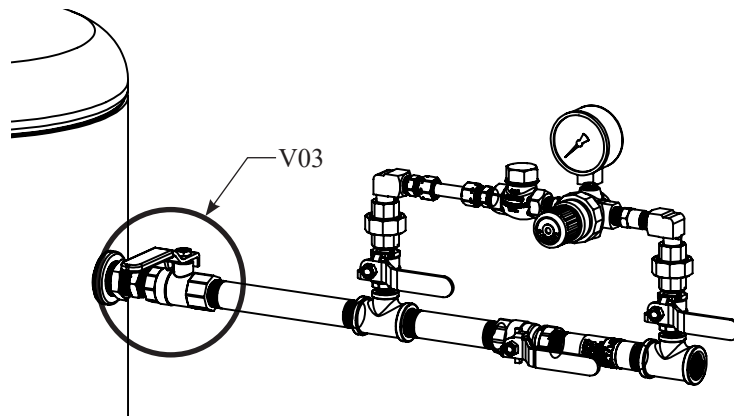

4. Open the blue N₂ Bleed Valve (V01) located near the Nitrogen Sample Port (SP) and begin draining pressure from the nitrogen tank. See Fig. 33.

Fig. 33

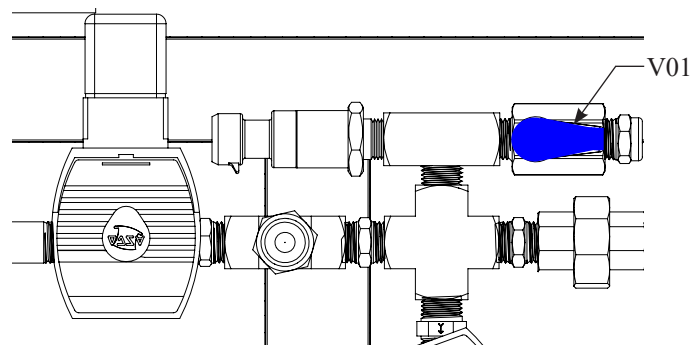

Compressor Air Intake Filters:

5. When the pressure has been drained from the nitrogen generator, replace the air intake filter.
6. Go to the air compressor located inside the nitrogen cabinet. Locate the black air filter. See Fig. 34.

Fig. 34 INS-250 Compressor Shown

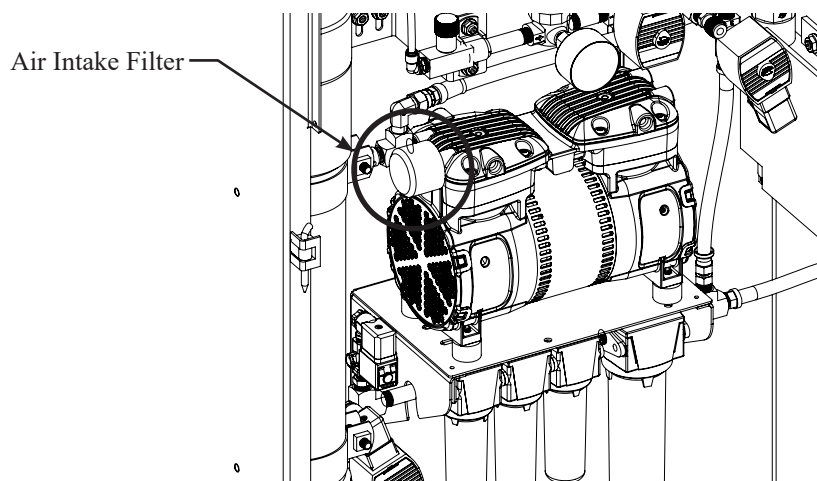

7. Unscrew the filter and replace.

Filter Elements:

8. Locate the three (3) filters on the inside of the nitrogen generator cabinet. The largest filter labeled WS01 does not have a serviceable filter element and does not need to be unscrewed. See Fig. 35.

Fig. 35

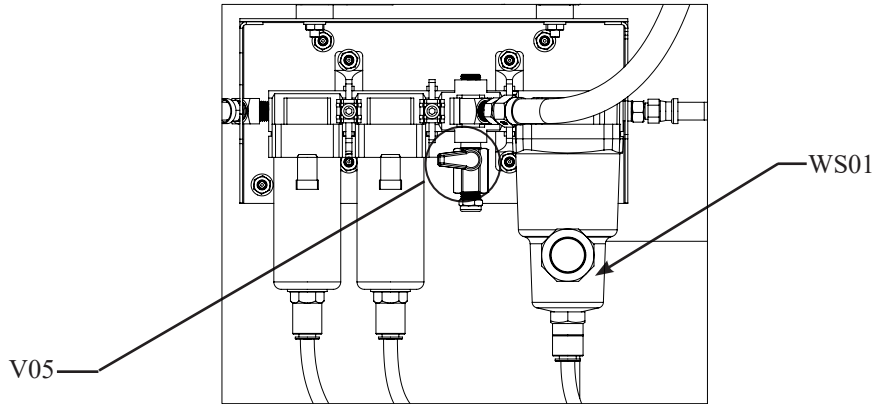

9. Locate the Air Bleed Valve (V05). Open valve to drain any residual pressure in the nitrogen generator.
10. Disconnect the drain tubes from the filter bowl by pushing up on the plastic releasing collar and pulling down on the tube. See Fig. 36.

Fig. 36

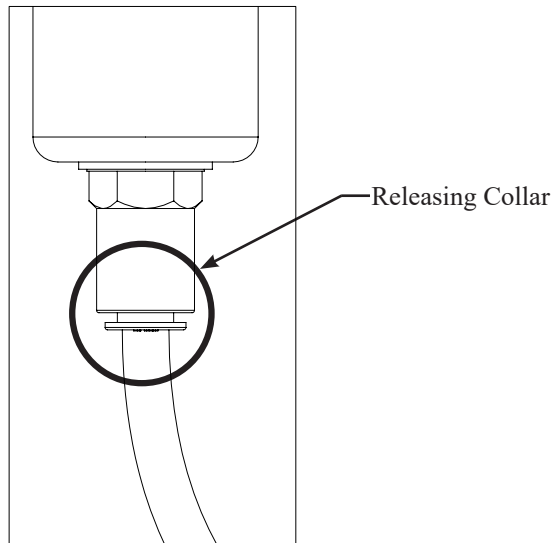

11. Slide the lock release down, rotate the bowl while pulling down on it to remove the bowl. See Fig. 37.

Fig. 37

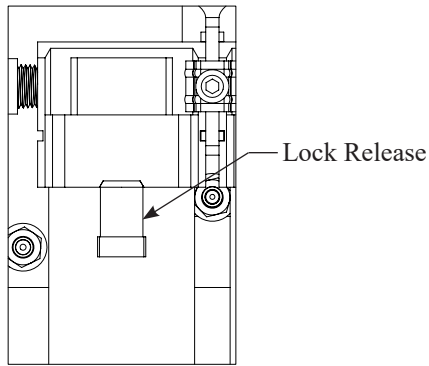

CAUTION

It is extremely important that you only unscrew the drain bowl from the filter body. The float adjustments at the bottom must remain in auto. Manual (man) will cause the floats to remain open and air to leak. If you accidentally loosen the float adjustment, simply retighten with your hand. See Fig. 38.

Fig. 38

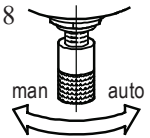

12. After the filter bowl is separated from the filter body, remove the filter element by gently pulling down. See Fig. 39.

Fig. 39

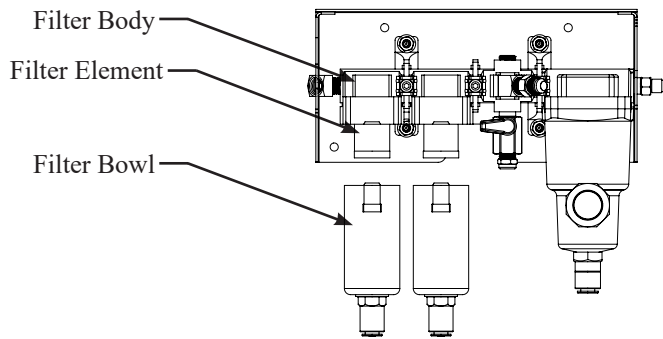

13. Replace the filter element with the correct filter element from the replacement kit (#0090263). See Fig. 40.

- a. Water Separator (#5230035) - No Element
- b. The filter body (#5230036) second from the right is the Stage 1 filter which has a YELLOW element (#5230039).
- c. The filter body (#5230037) third from the right is the Stage 2 filter which has a BLACK element (#5230040).

Note: This filter bowl is not connected to the drain and has a blue handled valve.

14. Remove old O-rings and replace with the O-rings in the filter element kit.

Fig. 40

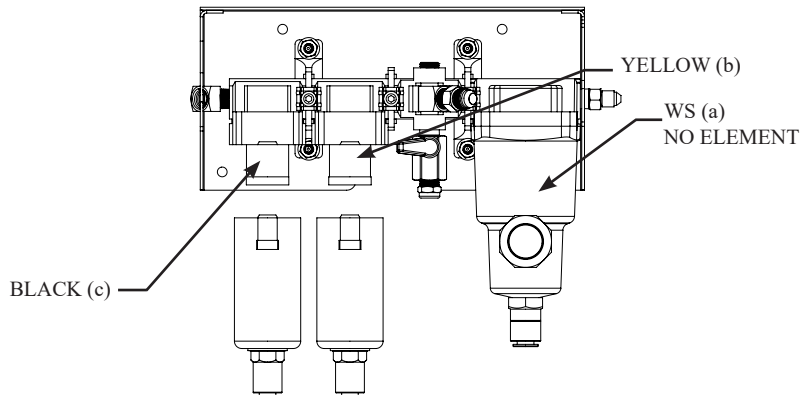

15. Clear filter bowls of debris.
16. Screw the filter bowl back into the filter body. Repeat for all filters. Plug back in the drain tubes.
17. Close the Air Bleed Valve (V05) and the blue N₂ Bleed Valve (V01).
18. Turn power on to the unit using the electrical disconnect.

Resetting Maintenance Alert and Checking for Leaks:

19. To reset the maintenance timer and get the maintenance alert or maintenance trouble to reset, go to the IntelliGen™ Display.
20. Press "MAINT" on the IntelliGen™ Display keypad.
21. Enter passcode "0000"
22. Select "Std. Maintenance" press "ENTER".
23. The menu will display maintenance timer countdown hours.
24. To reset the maintenance timer press "ENTER". Press "ENTER" again to confirm.
25. The maintenance light on the IntelliGen™ Display will turn off and the maintenance timer has been reset.
26. Turn power back on to the air compressor using the Air Compressor Switch located on the right of the cabinet. The amber "BYPASS" LED will be ON since there is no pressure in the tank.
27. If the nitrogen generator is isolated from the sprinkler system:
 - a. The air compressor of the INS-100 should take no longer than 8 minutes to pressurize the nitrogen tank and turn off.
 - b. The air compressor of the INS-250 should take no longer than 5 minutes to pressurize the nitrogen tank and turn off.
28. The amber "BYPASS" LED should turn off.
29. If the air compressor is not turning off or it is taking longer than expected, it could indicate a leak.
30. Allow the system to hold pressure for several minutes. Check all piping connections for leaks. Any drop in pressure on the nitrogen tank during this time could indicate a leak.
31. If there is a drop in pressure, leak check all filters.

Air Compressor Replacement

1. Isolate the nitrogen generator from the sprinkler system and relieve pressure.
2. Disconnect the power to the nitrogen generator using lockout-tagout procedure.
3. Remove cover from horizontal wire duct below the motor starter and vertical wire duct behind the compressor.
4. Disconnect compressor wires from motor starter and ground wire from terminal block.
5. Loosen flex hose fitting at the compressor discharge and remove from the compressor.
6. Remove the screw from the top of capacitor bracket located behind the compressor.
7. Remove compressor mounting nuts (located underneath compressor shelf).
8. Carefully remove wire from the black compressor sensor (CS1) located in the horizontal wire duct below the motor starter.
9. Slide capacitor out of the capacitor bracket.
10. Lift compressor off of the compressor shelf and remove from cabinet.
11. Remove ground wire from the back of the compressor and reinstall it on the new compressor.
12. Remove black air filter housing from compressor.
13. Remove stainless steel elbow from compressor discharge.
14. Remove brass tee from compressor leaving pressure relief valve attached.
15. Remove old PTFE Thread Seal Tape tape from stainless steel elbow and brass tee.
16. Re-tape stainless steel elbow and brass tee with 2-3 wraps of medium density PTFE Thread Seal Tape tape.
17. Reinstall brass tee into compressor discharge port.
18. Reinstall stainless steel elbow into brass tee.
19. Reinstall black air filter housing on new compressor.
20. Remove vibration isolators from compressor and reinstall them hand tight on outermost mounting holes on the bottom of the new compressor.
21. Locate the 2 capacitor wiring coming from the new compressor and insert them through the top of the black capacitor boot.
22. Connect capacitor wires to the appropriate capacitor terminals.
23. Stretch capacitor insulator boot completely over the black terminal insulators on the capacitor.
24. Mount compressor to compressor shelf by inserting vibration isolators through the appropriate holes in the compressor shelf, reinstalling nuts on the underside of the shelf and tightening to 20 ft/lbs.
25. Refer to model voltage and find the correct wiring diagram on page 42-45.
26. Reinstall ground wire into ground terminal block.
27. Connect appropriate wires to the motor starter terminals, be sure the white wire goes through the hole on the compressor sensor (CS1).
28. Insert capacitor into the capacitor bracket and tighten screw.
29. Neatly place excess wire into wire duct and reinstall all covers.
30. Reinstall flex hose on compressor discharge.
31. Restart unit and check for leaks.

Nitrogen Membrane Replacement

1. Isolate the nitrogen generator from the sprinkler system and relieve pressure from the nitrogen generator.
2. Disconnect the power to the nitrogen generator using lockout-tagout procedure.
3. Remove the top tube to the nitrogen membrane.
4. Remove the bottom tube to the nitrogen membrane.
5. Loosen the clamps holding the nitrogen membrane in place.
6. Remove push to connect fittings on old membrane and reinstall on new membrane.
7. Replace the old nitrogen membrane with the new nitrogen membrane. Check to ensure inlet and outlet on the membrane are in correct orientation.
8. Tighten the clamps down.
9. Reattach both the top and bottom tube to the nitrogen membrane.
10. Turn on power to the nitrogen generator.
11. Retest nitrogen purity.

Maintenance Alerts and Actions

A maintenance alert is noncritical to the operation of the nitrogen generator. The maintenance light will turn on and a maintenance alert will appear on the IntelliGen™ Display. If connected to the IntelliView™ website, an e-mail will also be sent. The Trouble Horn will not sound and the BMS will not trip. Maintenance alerts can be cleared by performing maintenance on the unit then going into the "Maintenance Menu" and clearing the appropriate alert.

Maintenance Alert #1 - Standard Maintenance

Issue: Maintenance Timer expired after 1,000 hours and the nitrogen generator needs maintenance.

Action:

1. Within 250 compressor operating hours, complete standard maintenance following the procedure in this manual.
2. Reset Maintenance Alert #1 by going into the Maintenance Menu on the display and following the procedure on page 25.

Maintenance Alert #2 - Excess Nitrogen Demand (Sprinkler System Leak Rate Excessive)

Issue: Sprinkler system leak rate is greater than Leak Rate Warning Set Point. You have one week to address this before it turns into a trouble alert.

Action:

1. Leak check nitrogen generator and sprinkler system. Repair leaks if found.
2. Adjust Leak Rate Warning Set Point. See page 38 for details.
Note: Increased leak rates can cause excessive maintenance and damage to equipment.
3. Reset the Maintenance Alert #2 by going into the Maintenance Menu on the display.

Trouble Alerts and Probable Causes

A trouble alert is a critical alert to the operation of the nitrogen generator. The trouble light will turn on and a trouble alert will be created. If connected to the IntelliView™ website, an e-mail will also be sent. The Trouble Horn will sound and the BMS will trip. Trouble Alerts can be cleared by fixing the issue and pressing “CLEAR” on the display keypad, and entering passcode "0000".

Trouble Alert #1 - Nitrogen Generator in Bypass Mode for 2 hours

Issue: Bypass Solenoid Valve continuously ON for 2 hours.

Probable Cause:

1. Air compressor power is turned off.
2. Filling multiple sprinkler systems at one time.
3. Leak on nitrogen generator air compressor or sprinkler system.
4. Blockage in pathway from air compressor to nitrogen outlet.

Trouble Alert #2 - Air Compressor is Continuously Running

Issue: Air compressor continuously ON for 90 minutes.

Probable Cause:

1. Filling multiple sprinkler systems at one time.
2. Major leak on nitrogen generator.
 - a. Float valve on filters stuck open.
3. Leak on sprinkler system.
4. Air compressor not building adequate pressure.

Trouble Alert #3 - Excessive Air Compressor Cycling

Issue: Air compressor turns ON 10 times in 1 hour.

Probable Cause:

1. Leak on nitrogen generator and the N₂ tank inlet valve (V02) closed.
2. Leak on the sprinkler system.

Trouble Alert #4 - Excessive Membrane Runtime

Issue: Membrane Inlet Air Solenoid (XV01) and Membrane Outlet N₂ Solenoid (XV02) continuously ON for 30 minutes.

Probable Cause:

1. Leak on nitrogen generator or sprinkler system.
2. Air Compressor Power is turned off.
3. Membrane Inlet Air Solenoid (XV01) and/or Membrane Outlet N₂ Solenoid (XV02) are blocked, or closed.

Trouble Alert #5 - Excessive Membrane Cycling

Issue: Nitrogen valves turn ON 16 times in 4 hours.

Probable Cause:

1. Leak on sprinkler system.
2. Leak on nitrogen tank or fitting.

Trouble Alert #6 - Nitrogen Generator Cannot Keep Up While in Nitrogen Generating Mode

Issue: Bypass Solenoid cycles 16 times over 4 hours.

Probable Cause:

1. Filling multiple sprinkler systems.
2. Leak on nitrogen generator or sprinkler system.

Trouble Alert #7 - Excess Nitrogen Demand (Sprinkler System Leak Rate Excessive)

Issue: Sprinkler system leak rate is greater than Leak Rate Warning Set Point and has not been acknowledged for a week.

Probable Cause:

1. Leak on sprinkler system.
2. Leak on nitrogen tank.
3. Leak Rate Warning Set Point not appropriate for application.

Trouble Alert #8 - Max. Temperature Limit Reached

Issue: Internal cabinet temperature reached max. limit.

Probable Cause:

1. Cooling fan failure.

Trouble Alert #9 - Maintenance

Issue: Compressor Maintenance Timer expires when maintenance request has not been reset in 250 hours.

Probable Cause:

1. Standard maintenance was not completed.
2. Maintenance timer not reset.

Trouble Alert #10 - Hardware Failure Detected

Issue: IntelliGen™ Controller failure detected.

Probable Cause:

1. Short circuit on output wiring.

Trouble Alert #11 - PLINK Connection Error

Issue: Devices cannot communicate.

Probable Cause:

1. Wiring not correct.
2. Power failure.

Trouble Alert #12 - PLINK Device Trouble

Issue: One or more PLINK devices are reporting trouble.

Probable Cause:

1. An INS-PV connected to the generator has an error.
2. See INS-PV Manual #5401532.

Troubleshooting

Leak on Sprinkler System or Nitrogen Generator

1. View the Leak Rate (LR) by exiting to the main menu of the IntelliGen™ Display. It will be displayed as LR: # PSI/24HR.
2. If the Leak Rate (LR) is greater than 6 psi/24HR; there is an excessive leak.
3. Isolate the nitrogen generator from the sprinkler system using the N₂ Tank Outlet Valve (V03).
4. Allow the nitrogen generator to fill the nitrogen tank (refer to Page 18 if compressor is not running).
5. Once the air compressor turns off allow the nitrogen generator to sit for 30 minutes.
6. If pressure drops in the nitrogen tank that indicates there is a leak on the nitrogen generator.
7. Leak check all fittings and tighten fittings that are leaking. Avoid electronics.
8. If pressure does not drop, this indicates the leak is outside of the nitrogen generator. Check all piping downstream of the N₂ Tank Outlet Valve (V03). Fix leaks as needed.
9. Clear the trouble using the “CLEAR” button on the IntelliGen™ Display and enter passcode "0000".

Testing Nitrogen Flow Rate and Nitrogen Purity

1. Isolate the nitrogen generator from the sprinkler system using the N₂ Tank Outlet Valve (V03) on the nitrogen tank. Allow the nitrogen generator to fill the nitrogen tank.
 2. When the nitrogen tank pressure reaches approximately 80 psi the air compressor will turn off.
 3. To ensure the nitrogen generator is operating correctly and that the correct nitrogen purity is being produced a functional test must be performed.
 4. On the inside of the nitrogen cabinet, locate the blue N₂ Bleed Valve (V01) near the Nitrogen Sample Port (SP).
 5. Slightly open the blue N₂ Bleed Valve (V01) and begin draining the pressure out of the nitrogen tank.
 6. Quickly close the blue N₂ Bleed Valve (V01) when you see the red LED on the compressor unloader solenoid (XV04) turn on (compressor will turn on 10 seconds after LED turns on). This will happen at approximately 60 psi.
- Note:** If the pressure in the nitrogen tank drops below 55 psi the nitrogen generator will return to Bypass Mode. Wait for the nitrogen generator to refill the tanks and the unit to return to Nitrogen Generating Mode before trying again.
7. Begin timing to see how long it takes to reach approximately 80 psi in the nitrogen tank.
 8. If the nitrogen generator is isolated from the sprinkler system, it should take no longer than 8 minutes to pressurize the nitrogen tank to 80 psi on the INS-100 and 5 minutes to pressurize the nitrogen tank to 80 psi on the INS-250.
 9. During this time, connect the Portable Nitrogen Analyzer to the Nitrogen Sample Port (SP) to measure the purity of the exiting gas. The analyzer should read 98.0% +/-1%. This may take a few minutes.
 10. When the nitrogen generator reaches approximately 80 psi in the nitrogen tank, the air compressor will turn off.
 11. Allow the nitrogen generator to sit for 30 minutes.
 12. If pressure drops in either tank this indicates there is a leak in the nitrogen generator. Soap all pre-plumbed fittings and tighten any fittings that are leaking. Avoid electronics.
 13. If the pressure does not drop, this indicates the leak is outside of the nitrogen generator. Check sprinkler system for leaks.

Normal Operating Parameters of the INS-100/250

The Potter IntelliGen™ Nitrogen Generators are designed to deliver high purity nitrogen to the fire protection system. A pressure transducer on the nitrogen tank controls the valves on the inside of the cabinet. Whenever the nitrogen tank requires nitrogen, the valves open allowing air to flow from the air tank. When the nitrogen tank reaches the desired set point the valves close.

- Periodic running of the air compressor is expected (typically less than 24 times a day).

	INS-100	INS-250	Recorded Parameter
Air Compressor Operating Pressure*	80 psi	110 psi	
Nitrogen Tank OFF Pressure*	80 psi	80 psi	
Nitrogen Tank ON Pressure*	60 psi	60 psi	
Max time interval to build pressure from 60 psi to 80 psi in nitrogen tank in Nitrogen Generating Mode	8 minutes	5 minutes	

*Pressures are approximated and can vary ± 3 psi.

Nitrogen Generator Leak Detection System

Each Potter IntelliGen™ Nitrogen Generator comes with an integrated Leak Detection System. The Leak Detection System uses pressure decays to calculate the actual pressure loss in 24 hours, or the Leak Rate of the sprinkler system.

This Leak Rate is displayed on the IntelliGen™ Display as “LR # PSI/24HR”. # is the pressure in psi that is calculated.

Increases in the Leak Rate can cause excessive demand on the nitrogen generator. Excessive demand causes increased runtimes on the unit. Increased runtimes increase the frequency of maintenance and repairs. In some cases, excessive Leak Rates can cause catastrophic failures.

The Leak Detection System is designed as a rolling average over 1 week to ensure the presence of an actual leak. To reset the LR number, reset the Maintenance Alert #2 under maintenance on the IntelliGen™ display.

All Potter IntelliGen™ Nitrogen Systems are designed to run approximately 1,000 operating hours in a typical year.

This translates to a maximum pressure loss of 6 psi in 24 hours. This is the default Leak Rate Warning Set Point. If the actual Leak Rate of the sprinkler system is greater than that value, a maintenance alert or a trouble will display on the nitrogen generator.

The Leak Rate Warning Set Point in the Potter IntelliGen™ Nitrogen Generator is a user adjustable set point for when a maintenance or trouble alert is activated. It will give a preemptive warning that the system Leak Rates have increased above the acceptable level.

This Leak Rate Warning Set Point can be set from 1 psi up to 36 psi per 24 hours.

- NFPA 13 allows a leak rate of 1.5 psi loss per 24 hours for new systems.
- NFPA 25 allows a leak rate of 3 psi loss per 2 hours for existing systems.

WARNING

Increases in Leak Rates will cause more maintenance and possible failures.

Example: At a 6 psi loss per 24 hour leak rate, the unit will run approximately 1,000 hours per year. At a 36 psi loss per 24 hour leak rate, the unit will run approximately 6,000 hours per year. That means, at a 6 psi leak rate, the air compressor will be operating 11% of the year, compared to a 36 psi leak rate, where the air compressor will be operating 70% of the year.

To Change the Leak Rate Warning Set Point:

1. Press "ENTER" on the IntelliGen™ Display keypad.
2. Select "Settings" using the keypad.
3. Enter passcode "0000".
4. Select "Leak Rate". Press "ENTER".
5. Press "ENTER" to choose settings.
6. Select "Leak Rate Warning". Press "ENTER".
7. Using the directional arrows, adjust the leak rate limit number "--" PSI per 24 hours.
 - a. NFPA allows 1.5 psi per 24 hours on new systems.
 - b. Potter Nitrogen Generators are designed for 6 psi per 24 hours.
8. Press "ENTER" to confirm.
9. Press "ENTER" to acknowledge warning.
10. Press "ENTER" to accept change.
11. Press "ESC" to return to main menu.

The Leak Rate is also calculated based on the size of the sprinkler system the nitrogen generator is protecting. The INS-100 is factory set at 675 gallons (max) and the INS-250 is factory set at 1,000 gallons (max). This can be adjusted lower if the units are servicing smaller systems.

To Change the Sprinkler System Size:

1. Press "ENTER" on the IntelliGen™ Display keypad.
2. Select "Settings" using the keypad. Press "ENTER".
3. Enter passcode "0000".
4. Select "Leak Rate". Press "ENTER".
5. Press "ENTER" to choose settings.
6. Select "Sprinkler Capacity". Press "ENTER".
7. Using the numeric pad, enter the total system volume size in gallons.
8. Press "ENTER".
9. Press "ESC" to return to main menu.

INS-100/250 Cabinet Dimensional Drawings

Weight: 130 lbs.

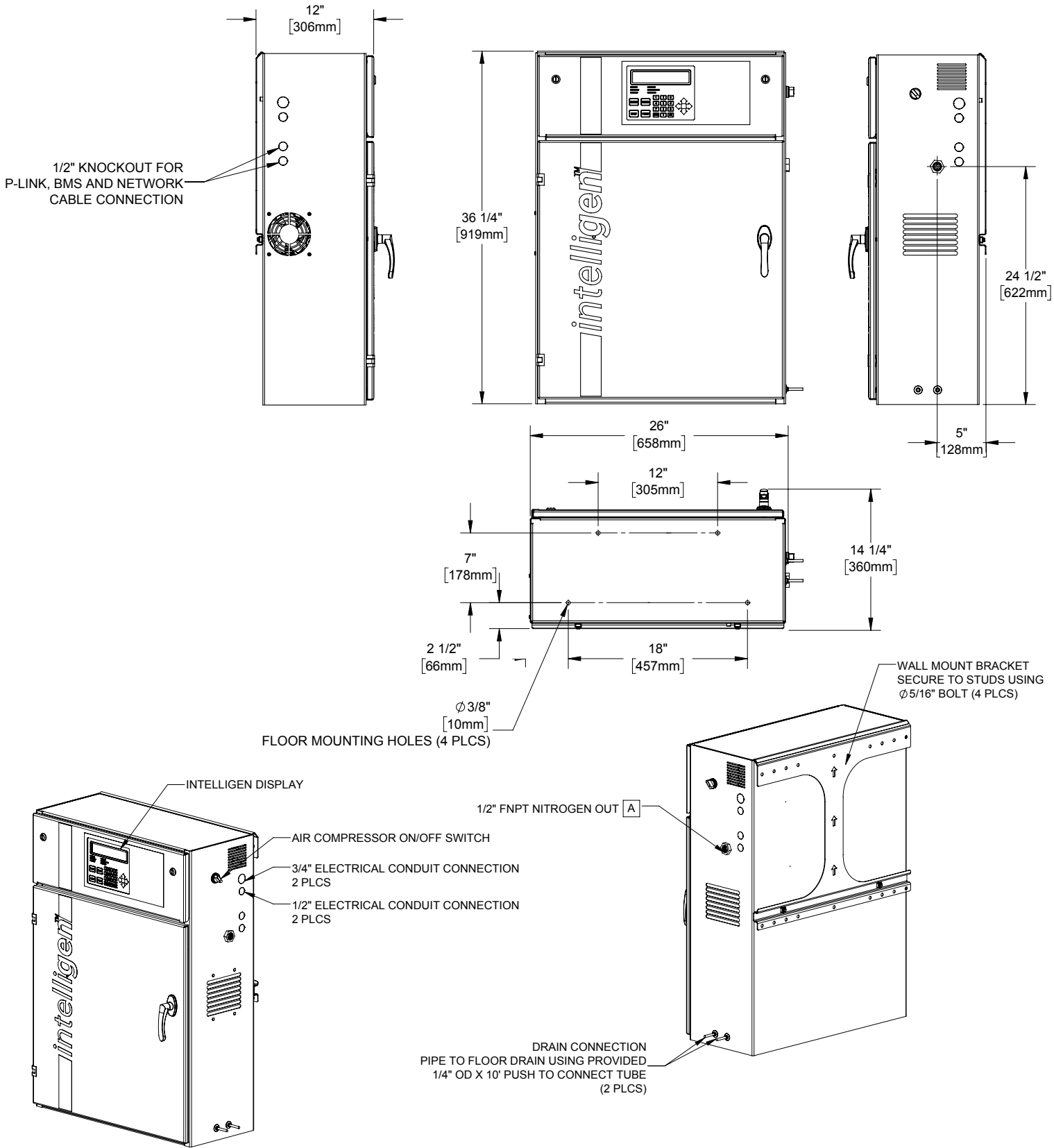

INS-100/250 Tank Dimensional Drawings

Weight: 45 lbs.

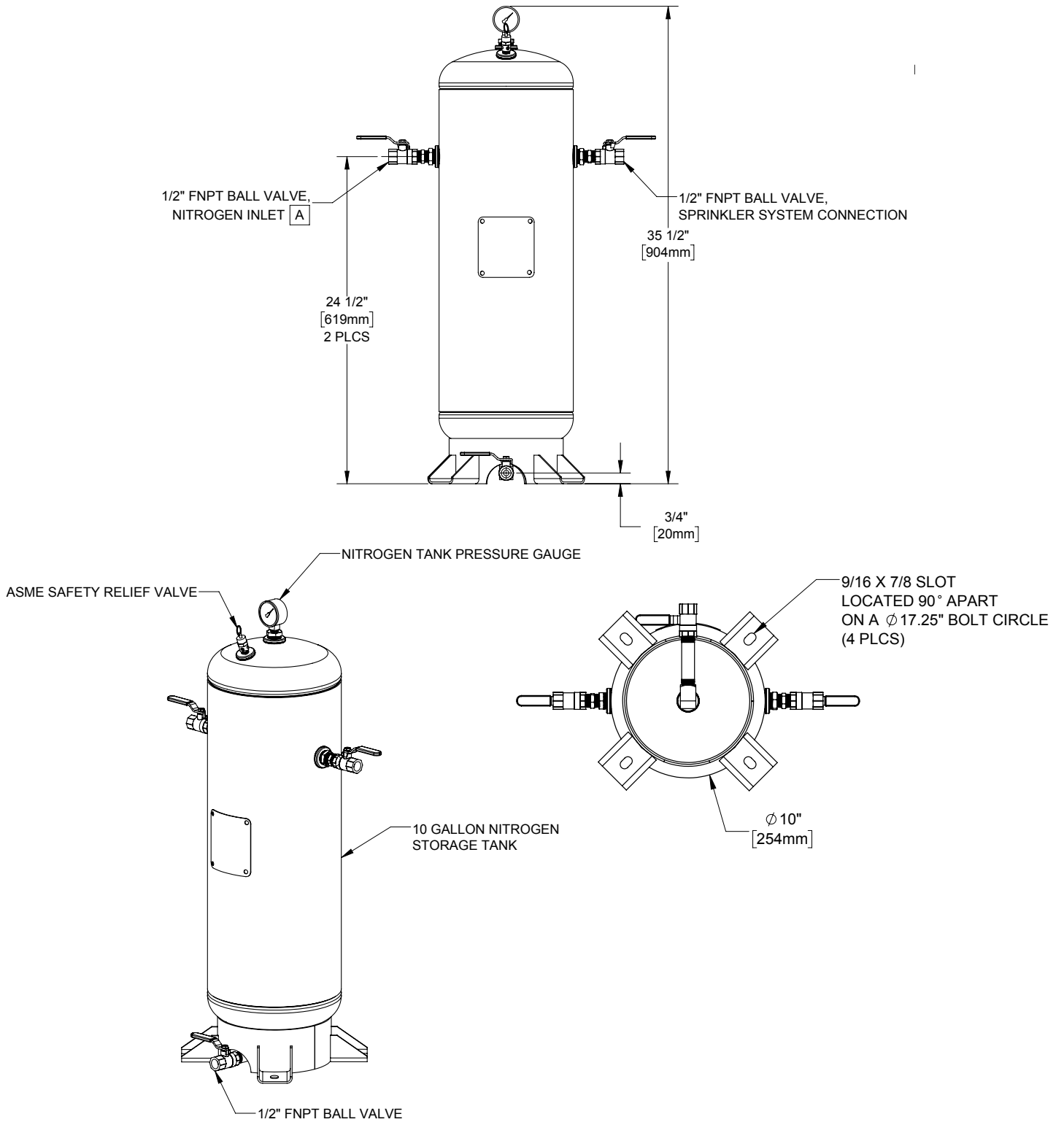

INS-100/250 PIPING/INSTRUMENTATION DIAGRAM

ITEM	DESCRIPTION
CA01	AIR COMPRESSOR
CAE01	AFTERCOOLER
CF01	COOLING FAN
CV01	CHECK VALVE
F01	COALESCING FILTER STAGE 1
F02	COALESCING FILTER STAGE 2
FCV01	FLOW CONTROL VALVE
M01	NITROGEN MEMBRANE
PI01	PRESSURE TRANSDUCER
PRV02	BACK PRESSURE REGULATOR
PSV01	PRESSURE SAFETY VALVE
PSV02	PRESSURE SAFETY VALVE
SP	NITROGEN SAMPLE PORT
TCN01	TANK COMPRESSED N ₂
V01	1/4" N ₂ BLEED VALVE
V02	1/2" N ₂ TANK INLET VALVE
V03	1/2" N ₂ TANK OUTLET VALVE
V04	1/4" N ₂ TANK MANUAL DRAIN
V05	1/4" AIR BLEED VALVE
WS01	WATER SEPARATOR
XV01	MEMBRANE INLET AIR SOLENOID
XV02	MEMBRANE OUTLET N ₂ SOLENOID
XV03	BYPASS SOLENOID VALVE
XV04	COMPRESSOR UNLOADER

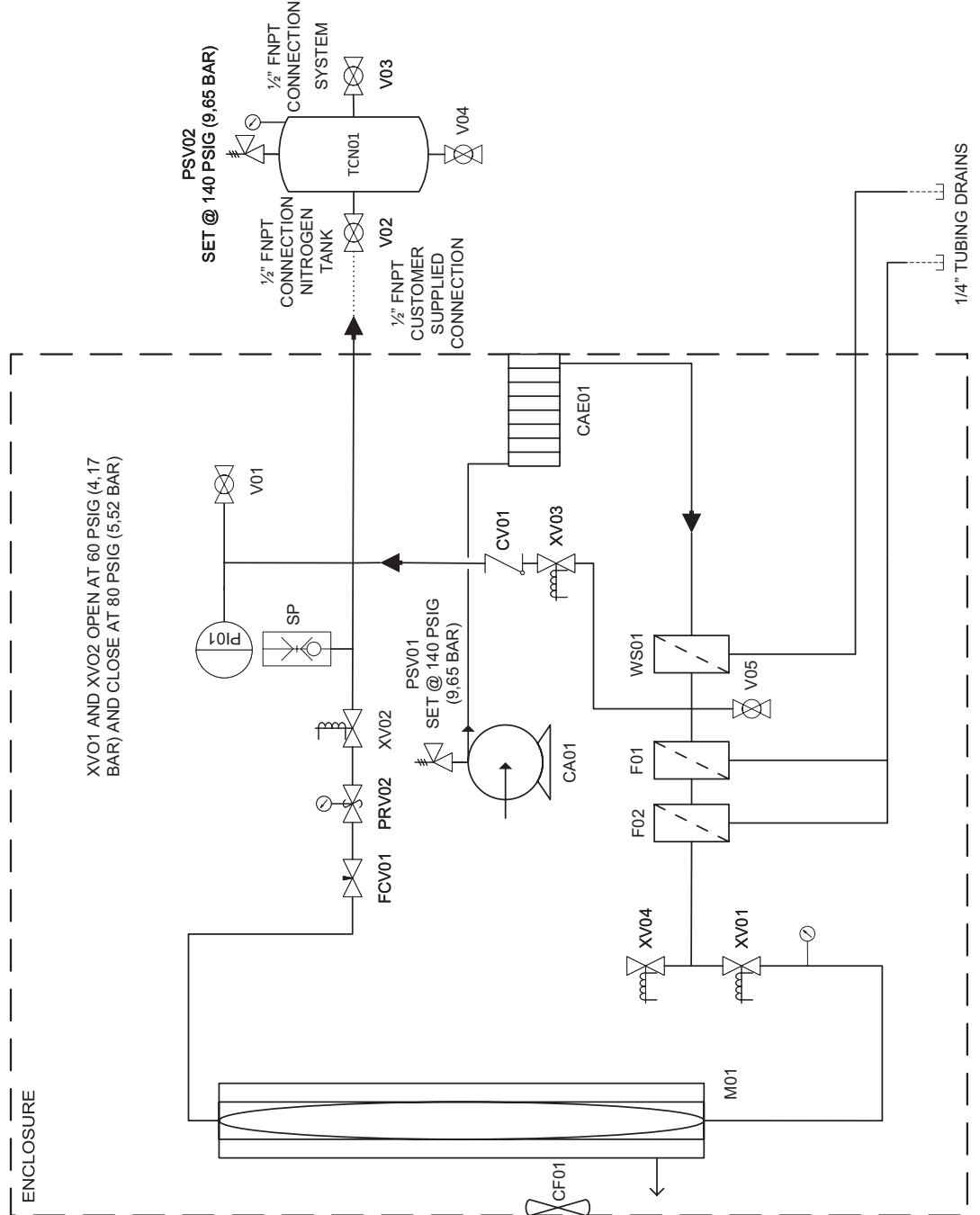

5406380-D

INS-100 100-120VAC 1PH 60HZ WIRING DIAGRAM

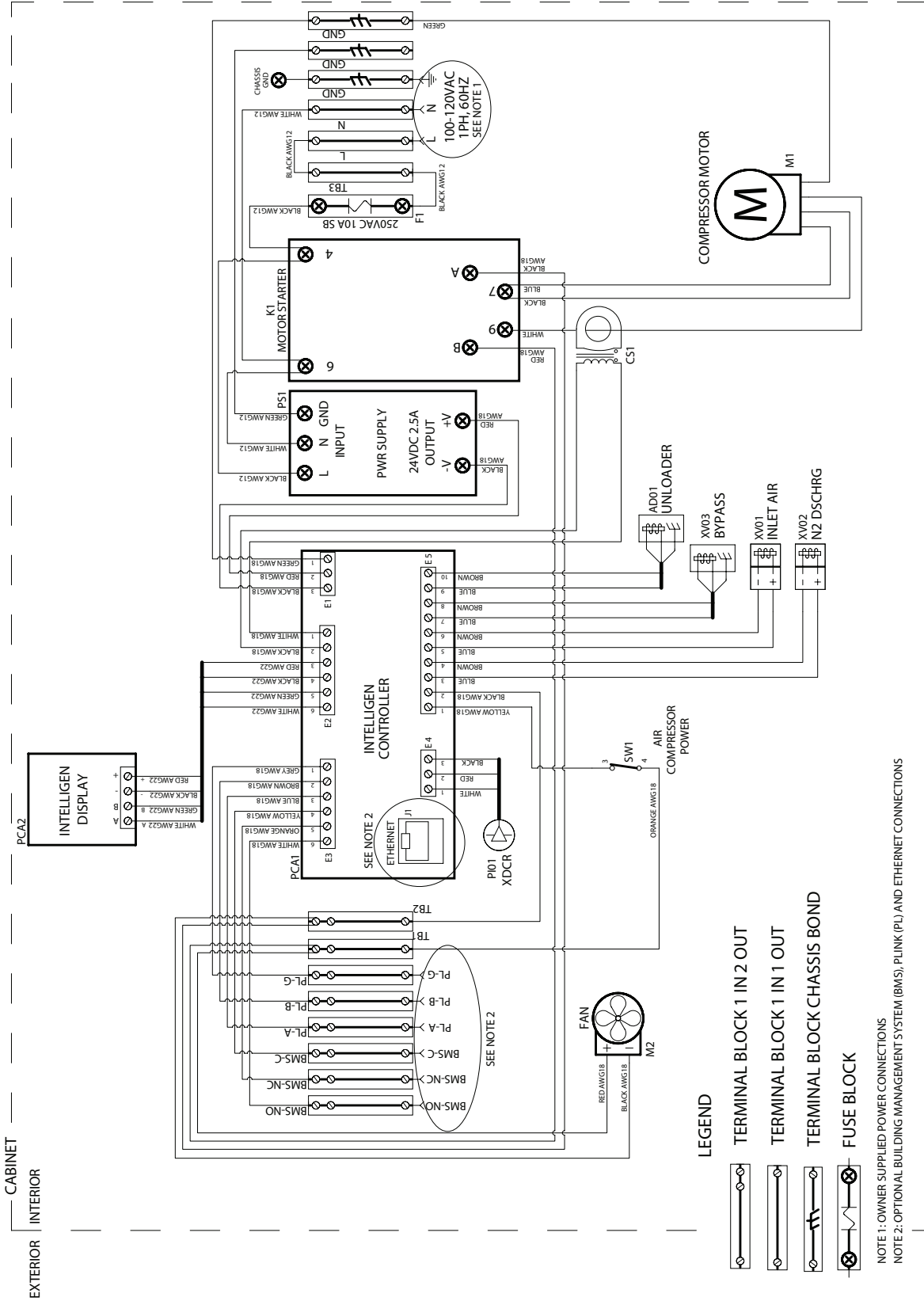

5406388 Rev. E

INS-100 200-240VAC 1PH 60HZ WIRING DIAGRAM

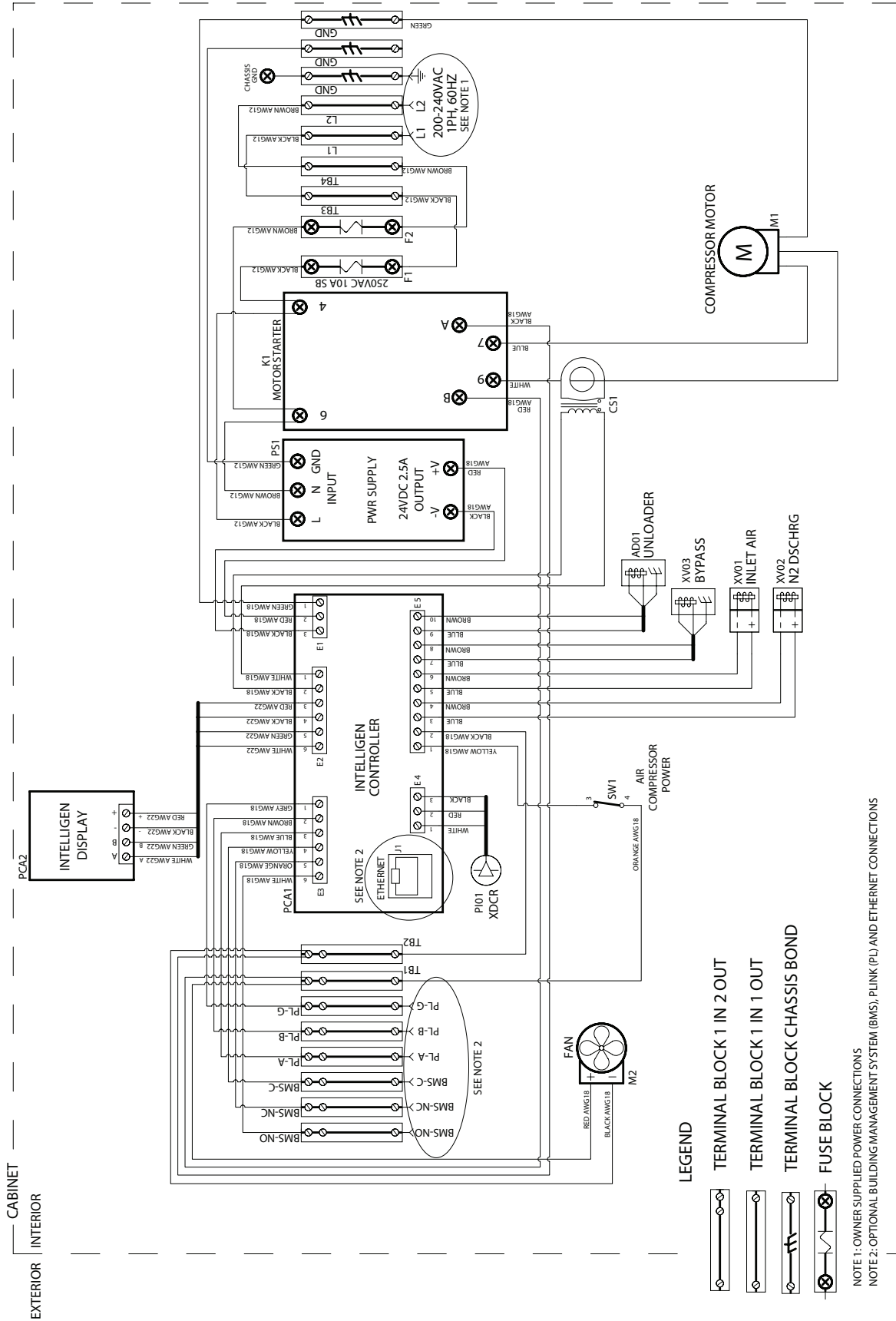

5406389 Rev. E

INS-250 115-120VAC 1PH 60HZ WIRING DIAGRAM

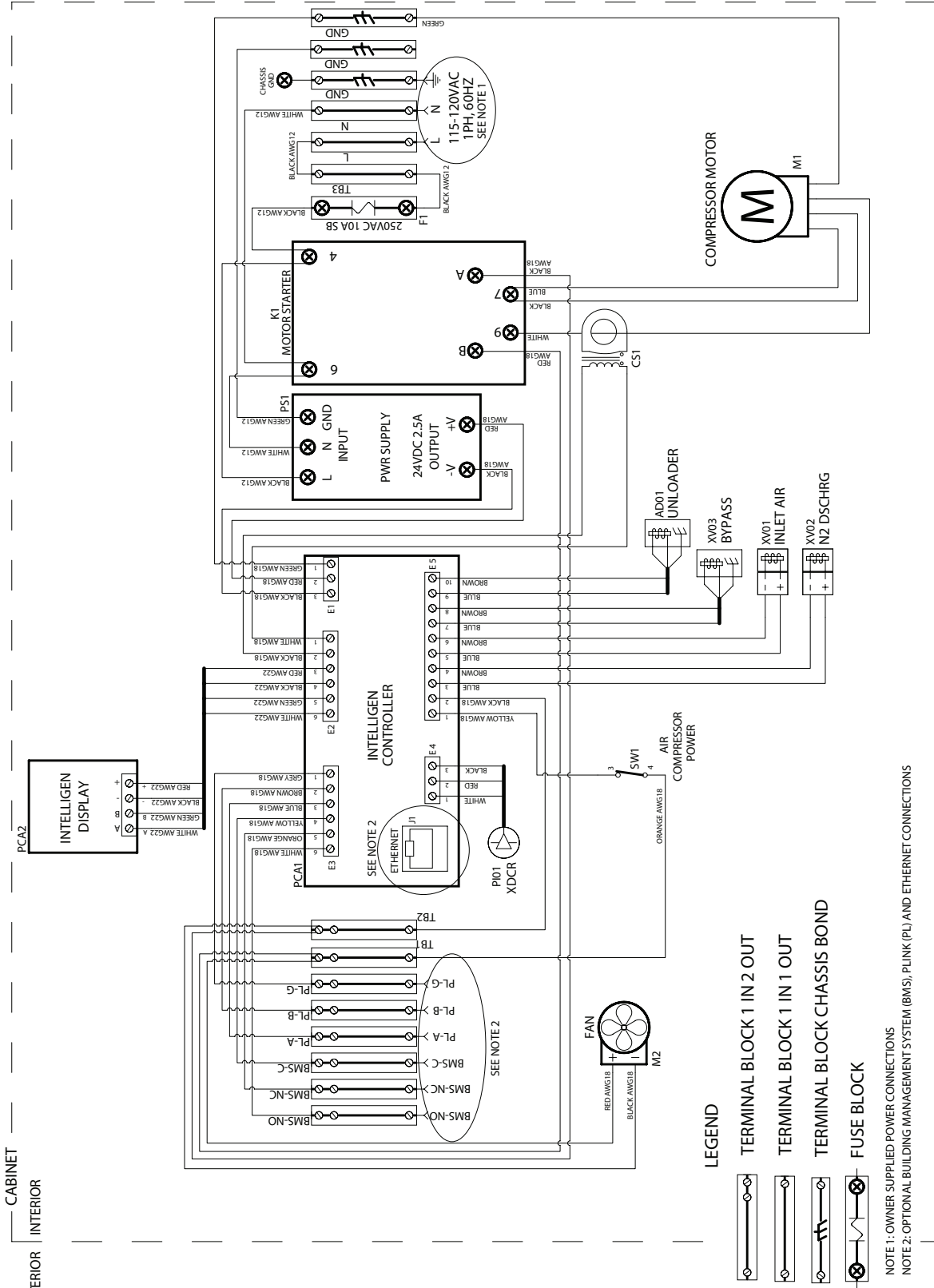

5406377 Rev E

INS-250 220-240VAC 1PH 60HZ WIRING DIAGRAM

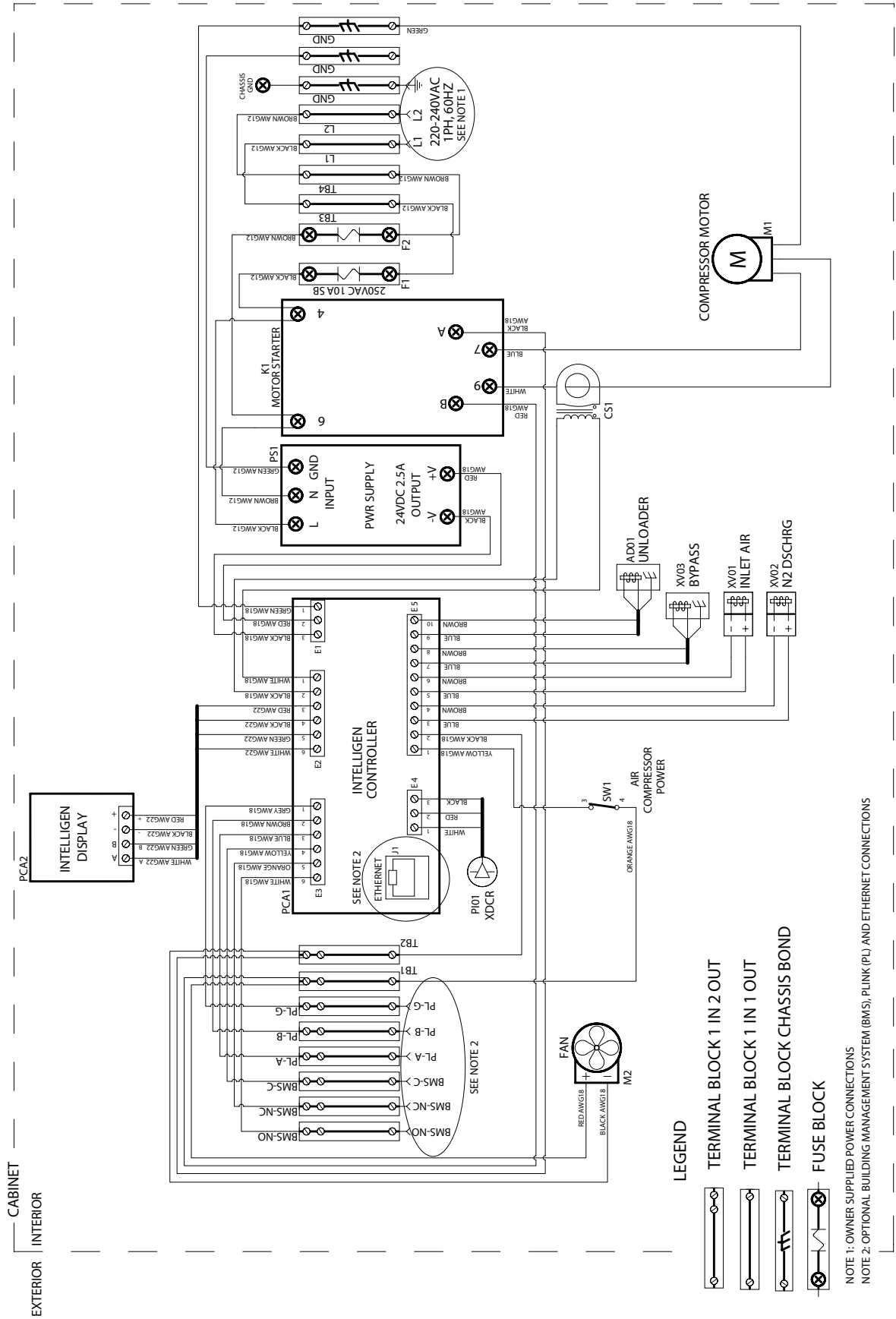

LEGEND

- TERMINAL BLOCK 1 IN 2 OUT
- TERMINAL BLOCK 1 IN 1 OUT
- TERMINAL BLOCK CHASSIS BOND
- FUSE BLOCK

NOTE 1: OWNER SUPPLIED POWER CONNECTIONS
 NOTE 2: OPTIONAL BUILDING MANAGEMENT SYSTEM (BMS), PLINK (PL) AND ETHERNET CONNECTIONS

5406378 Rev. E

Menu Trees

1. Menu Tree 1

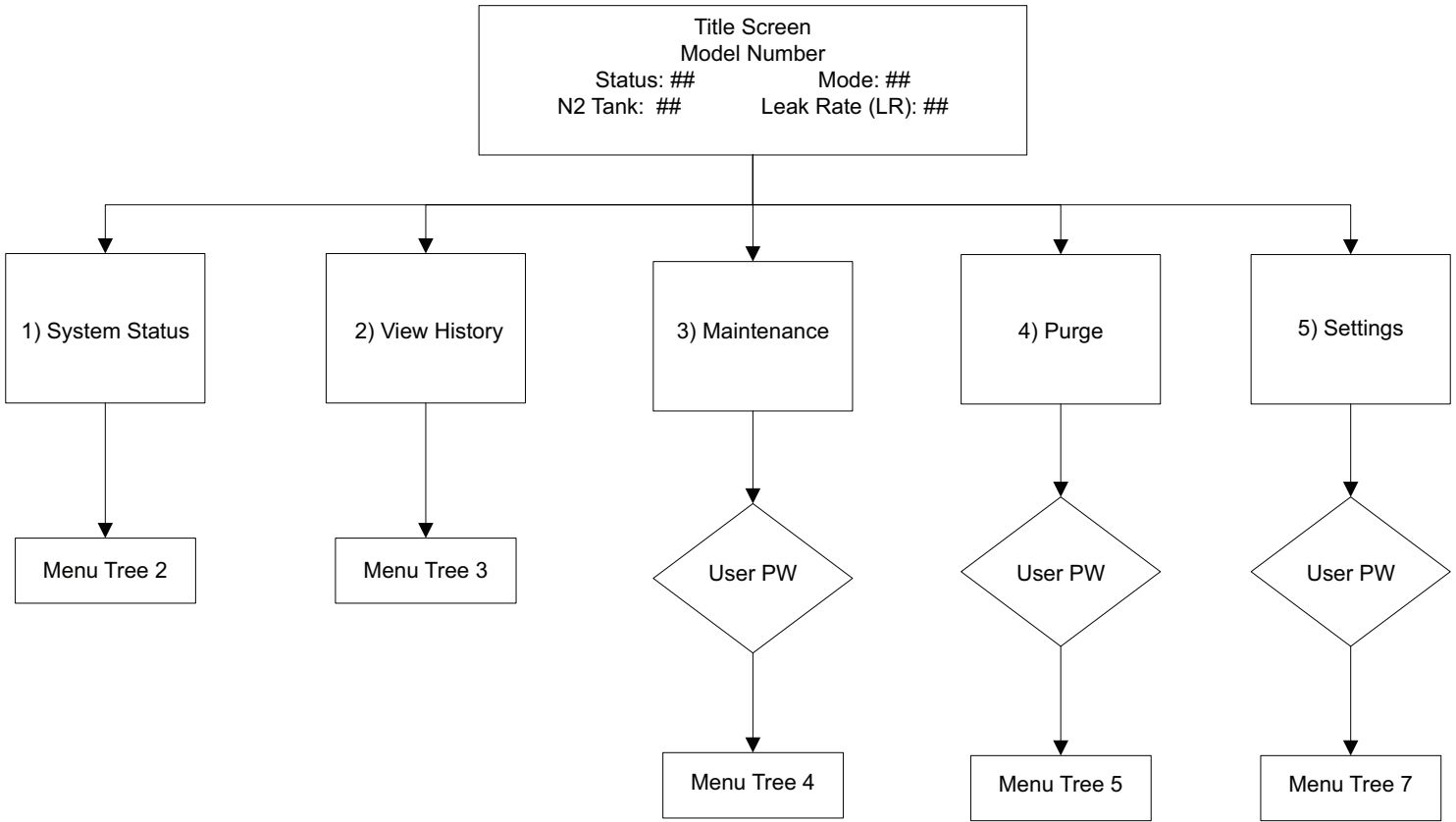

2. Menu Tree 2

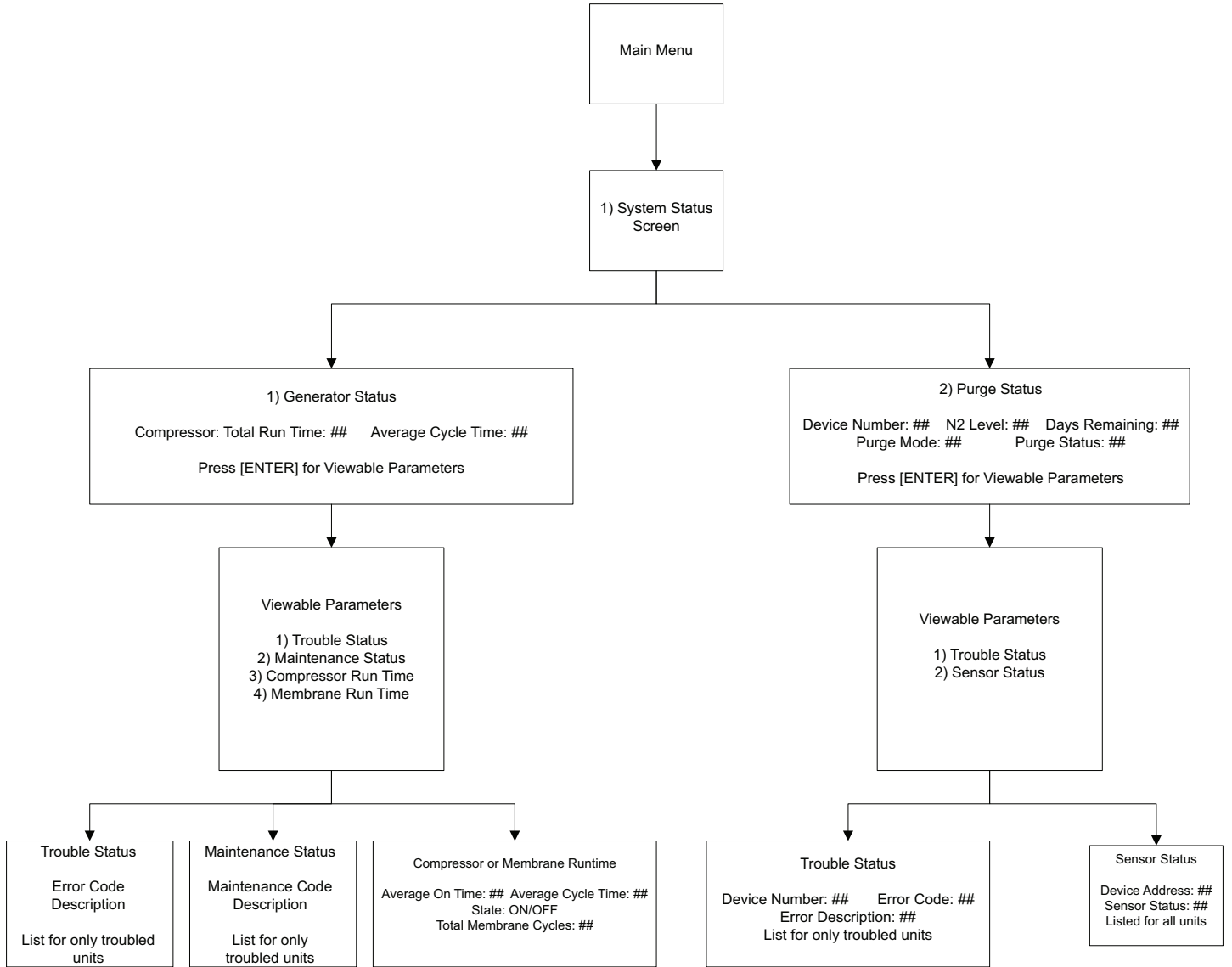

3. Menu Tree 3

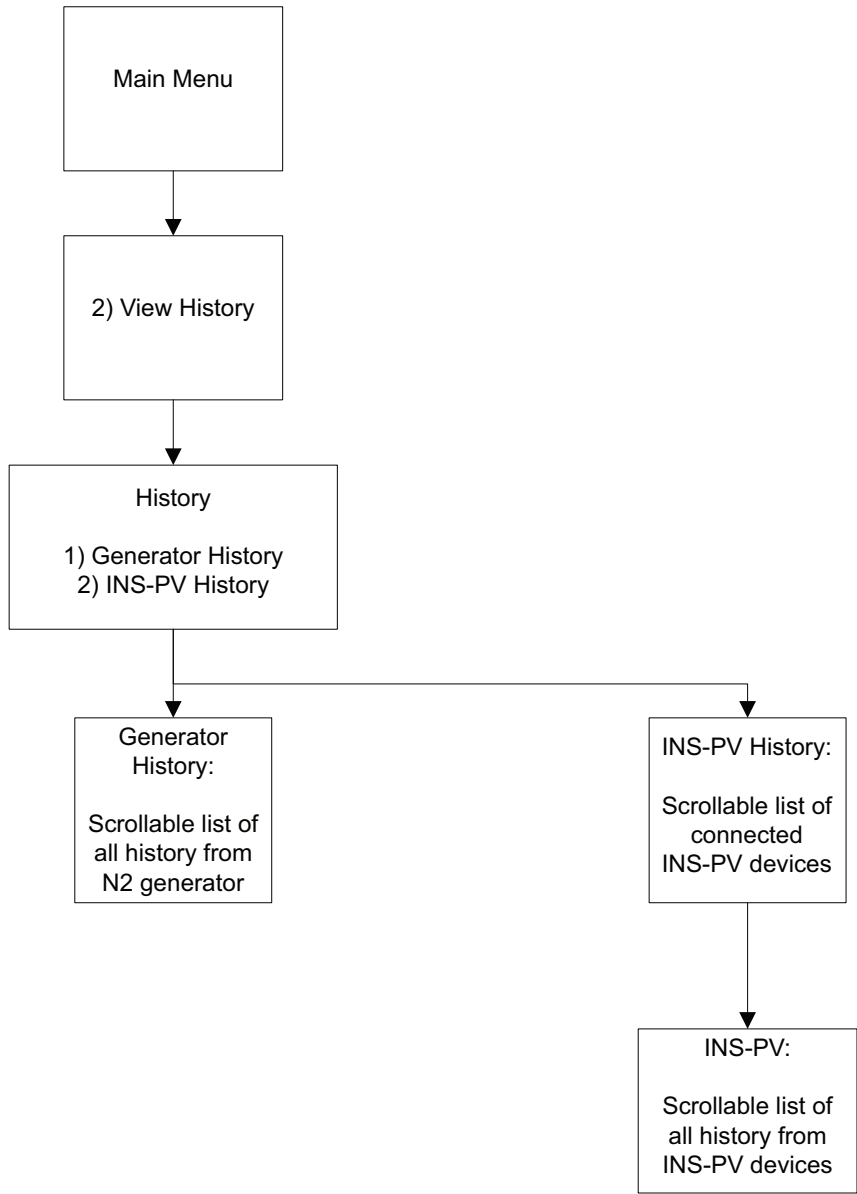

4. Menu Tree 4



5. Menu Tree 5

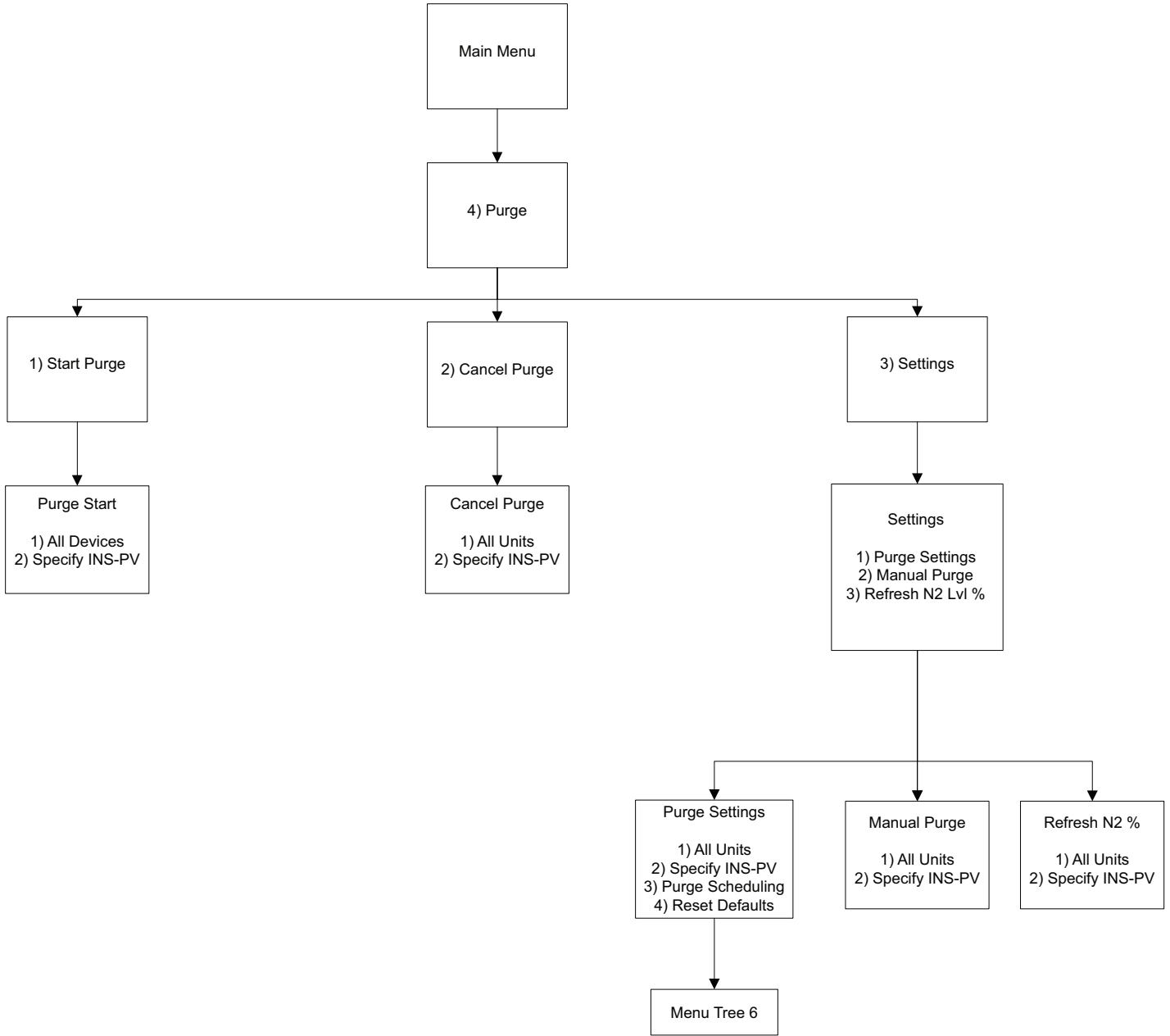

6. Menu Tree 6

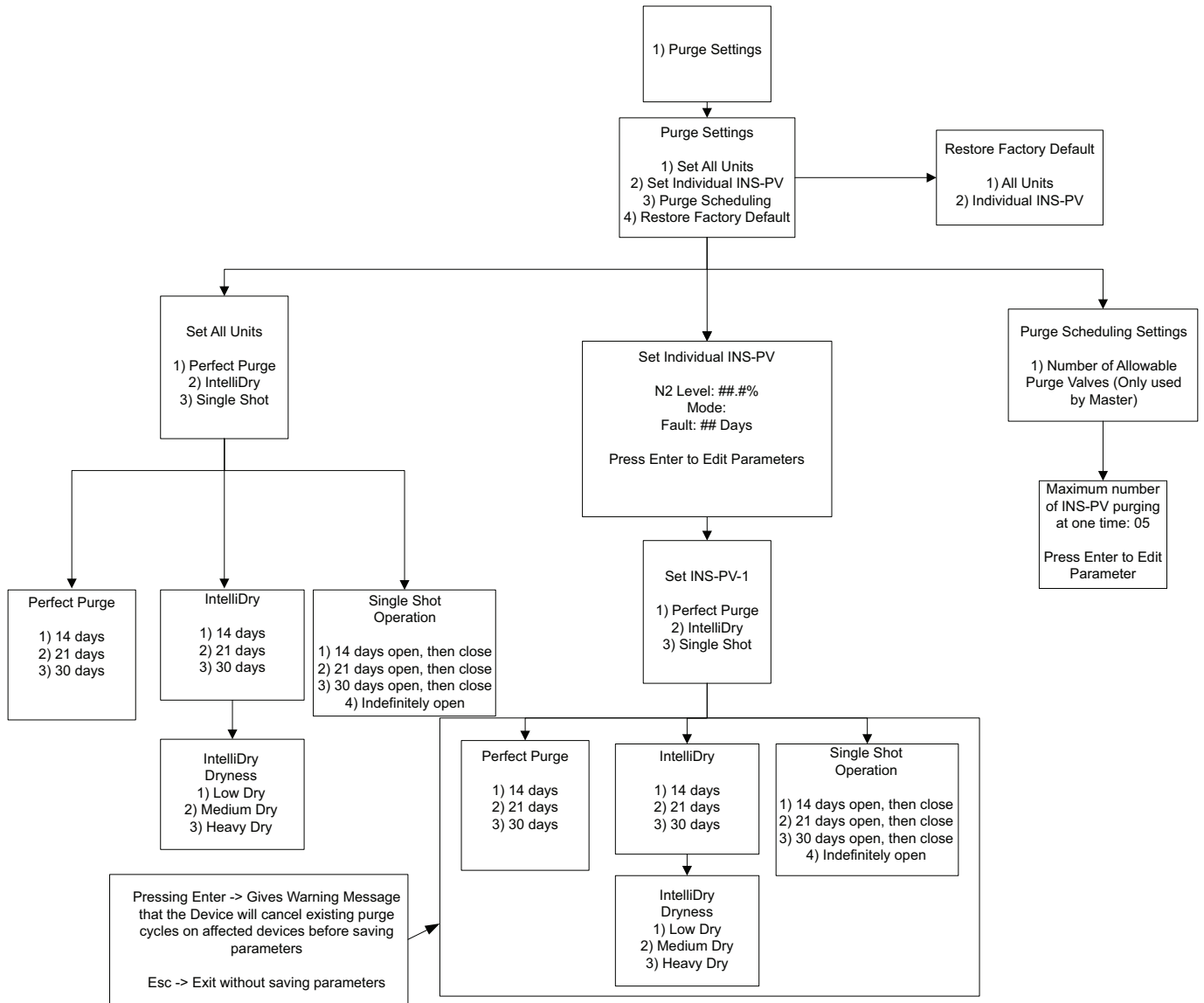

7. Menu Tree 7

