

# **SureCall Guardian3 QR (Quick Response)<sup>™</sup>**

User and Installation Guide



Public Safety Bands BDA for First Responders

Supports 700 MHz (FirstNet Ready), 800 MHz and 900 MHz SMR



# FCC Notice

---

The SureCall Guardian3 QR signal booster is a 90.219 Class B Device. Under Section 90.219(d)(5) of the Commission's rules, all Part 90 Class B signal booster installations must be registered with the FCC. In February 2013, as part of the Commission's efforts to support the continued use of signal boosters in the Private Land Mobile Radio Services and Public Safety Radio Services, the Commission adopted a registration requirement for existing and future Part 90 Class B signal booster installations. The Commission found that a Class B signal booster registration system would be a valuable tool to help resolve interference should it occur.

All Part 90 licensees and signal-booster operators must register existing Part 90 Class B signal boosters with the Commission by November 1, 2014. In addition, any new Class B signal booster installed after November 1, 2014 must be registered prior to operation.

Filing Registrations. To register a Part 90 Class B signal booster, go to the Part 90 Signal Booster Registration and Discovery page at [www.fcc.gov/signal-boosters/registration](http://www.fcc.gov/signal-boosters/registration). Enter an FCC Registration Number (FRN) and Password in the upper-right corner of the screen. Then click on "LOGIN."

On the Signal Booster Information page, enter either (1) latitude and longitude (in decimal degrees) of the booster location and click on the "Get Address Info" button; or (2) the booster, city, and state, and click on the "Get Lat/Long button. The registration tool will provide a map of the booster location to verify the location is correct. Next, check the box(es) for the frequencies within the operating range of the signal booster and enter at least one call sign associated with the booster. Then enter the filer's Company Information (Company Name, Company Attention, Address, Email registration, enter Signature Information (Title, Name), and click "Submit." The system will generate a confirmation, including a booster ID number, which you may print for your records. Each booster must be submitted separately. Using the links in the upper-right corner of the Signal Booster Confirmation page, you can "Add a Booster," "View Your Boosters" or "Log out."

Accessing Registrations. Each registration will be available to the public on the same day it is filed with the Commission. Registrations may be accessed at: [www.fcc.gov/signal-boosters/registration](http://www.fcc.gov/signal-boosters/registration). Click on "View All Boosters" from the Part 90 Signal Booster Registration and Discovery page. The registrations can be searched and sorted by booster ID number, name of the filer, city, county, state, zip code, latitude/longitude, or call sign.

For further information please contact the FCC Licensing Support Hotline at (877) 480-3201 or submit an online help request at <https://esupport.fcc.gov/onlinequest.htm>. Support hours are Monday thru Friday, 8:00–6:00 p.m. Eastern Time, except for Federal holidays.

<b>Chapter 1: Introduction &amp; Overview</b> .....	<b>4</b>
1.1 Product Overview .....	4
1.2 Package Contents .....	4
1.3 Additional Items Needed.....	4
1.4 Key Features & Benefits .....	4
1.5 Optional Accessories .....	5
1.6 How it Works.....	6
1.7 FCC and IC Compliance .....	6
1.8 Single vs. Multiple Carrier Operation .....	6
1.9 A Word About Safety .....	6
<b>Chapter 2: BDA Interface &amp; Connections</b> .....	<b>7</b>
2.1 Guardian3 QR BDA Interface Overview .....	7
2.2 RF Interfaces (A1 & A6).....	8
2.3 Power Interface for 110VAC or UPS Output (A5).....	8
2.4 RS-232 Interface for UPS (A3).....	9
2.5 Alarm I/O Interface (A2) .....	10
2.6 Ethernet Interface (A4).....	12
2.7 USB Interface .....	12
2.8 Alarm LEDs (A8) .....	13
<b>Chapter 3: Planning the Installation</b> .....	<b>14</b>
3.1 Installation Overview .....	14
3.2 Exterior Antenna .....	15
3.3 Interior Antennas .....	16
3.4 Antenna Separation.....	17
3.5 Locating the BDA .....	18
3.6 Accessories.....	18
3.7 Need Help? .....	19
<b>Chapter 4: Installation</b> .....	<b>20</b>
4.1 Soft Installation .....	20
4.2 Exterior Antenna.....	20
4.3 Interior Antennas .....	21
4.4 Mounting the BDA .....	22
<b>Chapter 5: Configuration &amp; Testing</b> .....	<b>23</b>
5.1 Powering on the BDA .....	23
5.2 DIP Switch Configuration.....	23
5.3 Band LED Conditions .....	25
5.4 Testing & Troubleshooting .....	26
<b>Chapter 6: Alarm Interface, Definitions &amp; Conditions</b> .....	<b>27</b>
6.1 Interface & Diagrams .....	27
6.2 Summary Alarm Trigger Conditions .....	27
6.3 Alarm LED Descriptions .....	29
<b>Chapter 7: Sentry Configuration &amp; Monitoring</b> .....	<b>30</b>
7.1 Sentry Software Introduction .....	30
7.2 Software Installation .....	30
7.3 Hardware Installation.....	34
7.4 Configuring the Booster System.....	36
<b>Chapter 8: Safety And Compliance</b> .....	<b>42</b>
8.1 FCC Compliance .....	42
8.2 A Word About Safety .....	42
<b>Chapter 9: Specifications</b> .....	<b>43</b>
<b>Chapter 10: Warranty</b> .....	<b>44</b>
10.1 Warranty Periods .....	44
10.2 Three-Year Product Warranty .....	44
10.3 Limitations of Warranty, Damages and Liability .....	45

# Introduction & Overview

---

## CHAPTER 1: INTRODUCTION & OVERVIEW

---

### 1.1 Product Overview

SureCall's Guardian3 QR is a bi-directional communications amplifier for police headquarters, fire stations, hospitals, and other first-responder facilities. The BDA services the full public safety 700MHz and 800MHz bands, and the 900MHz SMR frequencies (Specialized Mobile Radio Service).

The Guardian3 QR significantly improves the quality of crucial first-responder communications in buildings with weak signal strength. For optimal coverage, the BDA uses built-in safeguards to eliminate interference to public-safety networks. It meets NEMA 4 type requirements, and is upgradable in the field. Plus, the Guardian3 QR offers the industry's best three-year warranty available.

The Guardian3 QR is enclosed in a NEMA-4 compatible housing, and enhances the coverage area of first responder radio communications for in-building applications. It is equipped with bi-directional paths (down-link & up-link) for transmit and receive frequencies, and advanced filtering technology for low-noise amplification of signals.

### 1.2 Package Contents

Your BDA box contains the following items:

- Guardian3 Bi-directional Amplifier
- NEMA-4 rated housing
- Mounting kit
- DC power supply
- Wall anchors

### 1.3 Additional Items Needed

The Guardian3 QR needs the following additional components for a complete install:

- External antenna
- Lightning protector
- Cable splitter if installing multiple antennas
- Sufficient SC-400 ultra-low loss interior/exterior cable, 50 ohm
- Multiple antennas (omnidirectional domes and/or panels by SureCall)
- Grounded surge suppressor for DC power supply

### 1.4 Key Features & Benefits

- Suitable for large areas up to approximately 80,000 square feet depending on outside signal strength.
- Extends signals in areas with poor coverage due to geographical location and/or building design.
- Powerful in-building BDA with 31dB of adjustable gain level.
- NEMA-4 rated amplifier housing. No additional NEMA enclosure required.
- Integrated 7-pin alarm and UPS port for external battery backup.
- Power control maintains maximum output power at 26 dBm.

- Automatic oscillation detection and protection system powers down the BDA to prevent harmful radio interference.
- Automatic gain control (AGC).
- Features built-in SureCall Sentry remote-monitoring system with Ethernet port.

## 1.5 Optional Accessories

SureCall provides many optional features and accessories for the Guardian3 QR Amplifier. See table below:

Splitters and Couplers	
SC-WS-2	Wide Band 2 Way Splitter
SC-WS-3	Wide Band 3 Way Splitter
SC-WS-4	Wide Band 4 Way Splitter
SC-C-6	-6dB Coupler
SC-C-10	-10dB Coupler
Outdoor Antenna Options	
SC-288W	Wide Band Omni-directional 50 ohm Fiberglass Antenna 3 to 4dBi (includes mounting kit, 698-2700 MHz)
SC-230W	Wide Band Yagi Directional 50 ohm Antenna 10 to 11dBi gain (includes mounting kit, 698-960 & 1710-2700 MHz)
Inside Antenna Options	
SC-222W	Wide Band Dome 50 ohm Antenna - 3 to 4dBi (includes mounting kit, 698 -2700 MHz)
SC-248W	Wide Band Panel 50 ohm Antenna - 7 to 10dBi (includes mounting kit, 698-2700 MHz)
Plenum Cable	
SC-PL-30FT	30' SC400 Ultra Low Loss Coax Plenum Fire Rated Cable with N-Male connectors - Orange
SC-PL-75FT	75' SC400 Ultra Low Loss Coax Plenum Fire Rated Cable with N-Male connectors - Orange
SC-PL-1000FT	1000' SC400 Ultra Low Loss Coax Plenum Fire Rated Cable - Orange
Ultra Low Loss Cable	
SC-006-1000	1,000' SC600 Ultra Low Loss Coax Cable. Connectors not included - Black
Accessories & Connectors	
SC-LP	Lightning Protector
SC-ATNR-5	5 dB RF Attenuator
SC-ATNR-10	10 dB RF Attenuator
SC-ATNR-20	20 dB RF Attenuator
SC-CN-09	N Male Crimp Connector, 400 and Plenum Cable
SC-CN-12	N Male to N Male Connector
SC-CN-16	N Male Connector, 600 Cable
SC-Mount-Pole	L Bracket mount with U bolt hardware for donor antenna mount to J-bar
SC-Mount-JBar	Steel 1 inch J-Bar mount for donor antenna. Antenna mount not included

# Introduction & Overview

---

## 1.6 How it Works

The Guardian3 QR amplifies signals that reach a building from the nearest radio tower, and from radios inside the building going back to the tower. This compensates for weak reception caused by distance, topography, building structure, etc. The BDA receives the signal from an outside antenna, amplifies that signal, and then rebroadcasts it via antenna(s) inside the building, where it can then be picked up by radios inside. In the reverse direction, interior antennas also pick up signals coming from radios, where they are amplified by the BDA, and then passed to the exterior antenna for rebroadcast back to the tower.

## 1.7 FCC and IC Compliance

This is a Class B device. The product has been tested and found to comply with the Booster Requirements per FCC Part 90. The product has also been tested and found to comply with the Industry Canada (IC) RF Exposure Requirements, pursuant to IC RSS-131.

## 1.8 Single vs. Multiple Carrier Operation

SureCall's rated output power of this equipment is for single-carrier operation. It is recommended that you factor in loss when dealing with multiple carrier signals. We suggest 3 to 5 db loss factor.

## 1.9 A Word About Safety

Follow all safety precautions in this manual. This information is designed to prevent personal injury, equipment malfunction, and/or radio interference. You are responsible for ensuring a safe installation.

Your installation may require working in high locations such as roofs and/or ladders. Follow applicable safety regulations and best practices to avoid falling. Take care not to drop objects from any high area. Cordon off ground areas directly below the section of roof you are working on, or below your ladder whenever possible.

In addition, as a qualified installer, you are responsible for knowing and following all applicable codes and regulations and for obtaining all required permits and inspections.

Always use appropriate personal protective equipment such as goggles, gloves, hard hat, etc. as needed, and as required.



**WARNING: FAILURE TO EXERCISE CAUTION WHEN WORKING IN HIGH AREAS COULD CAUSE A FALL AND PERSONAL INJURY.**

## CHAPTER 2: BDA INTERFACE & CONNECTIONS

### 2.1 Guardian3 QR BDA Interface Overview

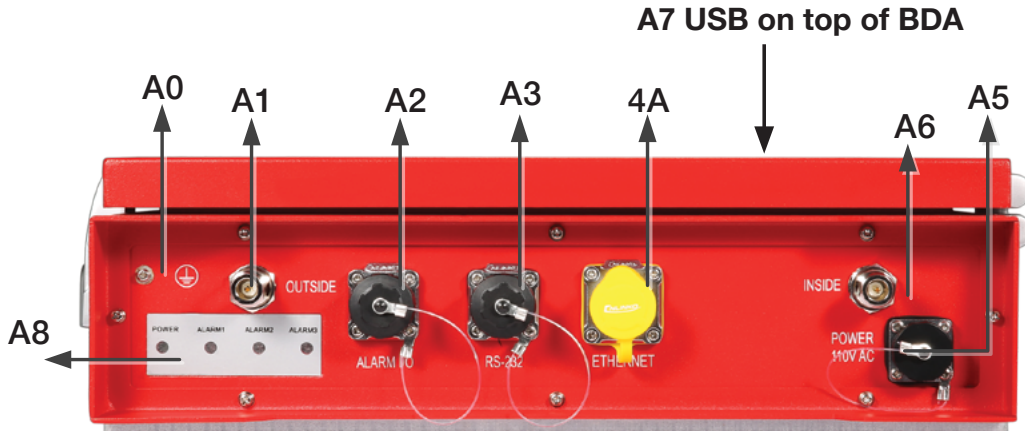

Interface Type	Definition	Description
A0	Grounding lug	Grounding lug
A1	OUTSIDE	N Female for OUTSIDE cable and antenna
A2	ALARM I/O	To Fire Department Control Box.
A3	RS-232	To UPS, Reserved for communication with UPS
A4	ETHERNET	Remote Monitoring Ethernet Port
A5	POWER 110VAC	Connect to 110VAC or 110V of UPS output
A6	INSIDE	N Female for INSIDE cable and antenna
A7	USB	USB port found on top of the BDA. Used to initialize the network connection devices
A8	Alarm LEDs	See Chapter 6 for details

# BDA Interface & Connections

## 2.2 RF Interfaces (A1 & A6)



A1 — N-type Female for OUTSIDE cable and antenna



A6 — N-type Female for INSIDE cable and antenna

## 2.3 Power Interface for 110VAC or UPS Output (A5)



A5 — Female 110VAC on BDA



Male 110v Connector Used for External Power Source (110VAC or UPS Output)

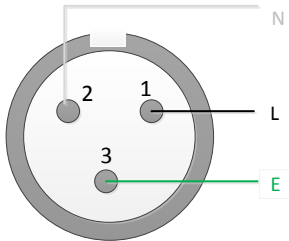

Female 110v (A5) Pinout Diagram

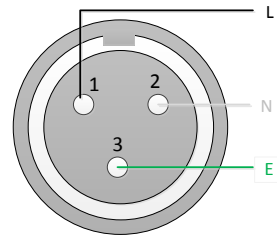

Male 110v Pinout Diagram



# BDA Interface & Connections

Pin Number	Definition	Full Name	Color	Note
1	L	Live Wire	Black	
2	N	Neutral Wire	White	
3	E	Earth Wire	Green	

## 2.4 RS-232 Interface for UPS (A3)



Female RS-232 Connector on BDA



Male RS-232 Connector  
Used for UPS Communications

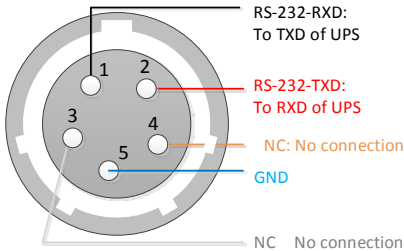

Female RS-232 (A3) Pinout Diagram

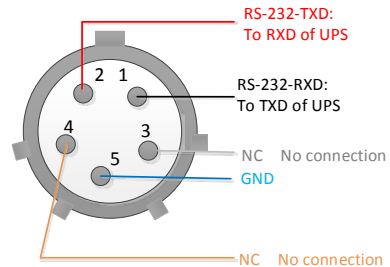

Male RS-232 Connector Pinout Diagram

Pin Number	Definition	Full Name	Color	Note
1	RS-232-RXD	RS-232 Receive Data	NG	External connection to TXD of UPS
2	RS-232-TXD	RS-232 Transmit Data	NG	External connection to RXD of UPS
3	NC	No connection	NG	
4	NC	No connection	NG	
5	GND	Ground	NG	

# BDA Interface & Connections

## 2.5 Alarm I/O Interface (A2)



Female Alarm Connector on BDA (A2)



Male Alarm Connector for Transfer to Fire Department Control Box

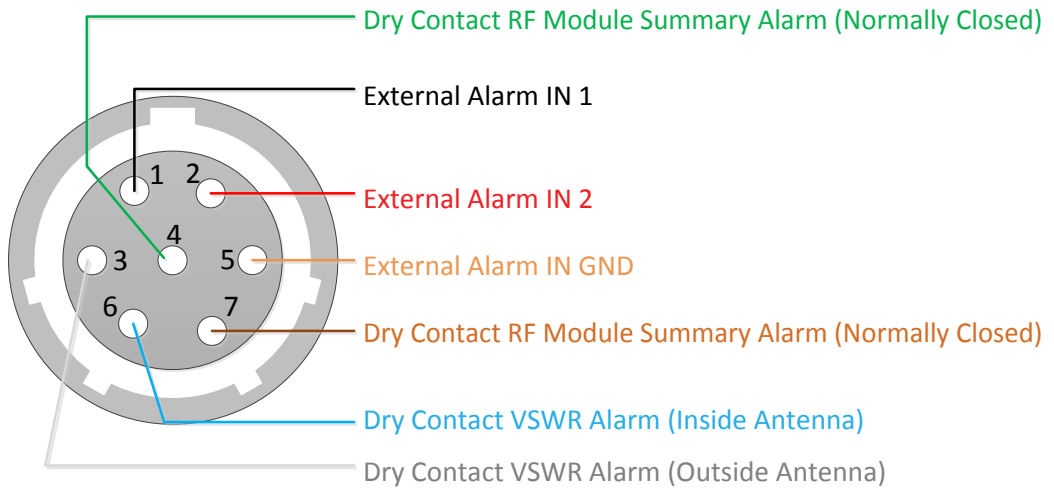

Female Alarm (BDA) Connector Pinout Diagram

# BDA Interface & Connections

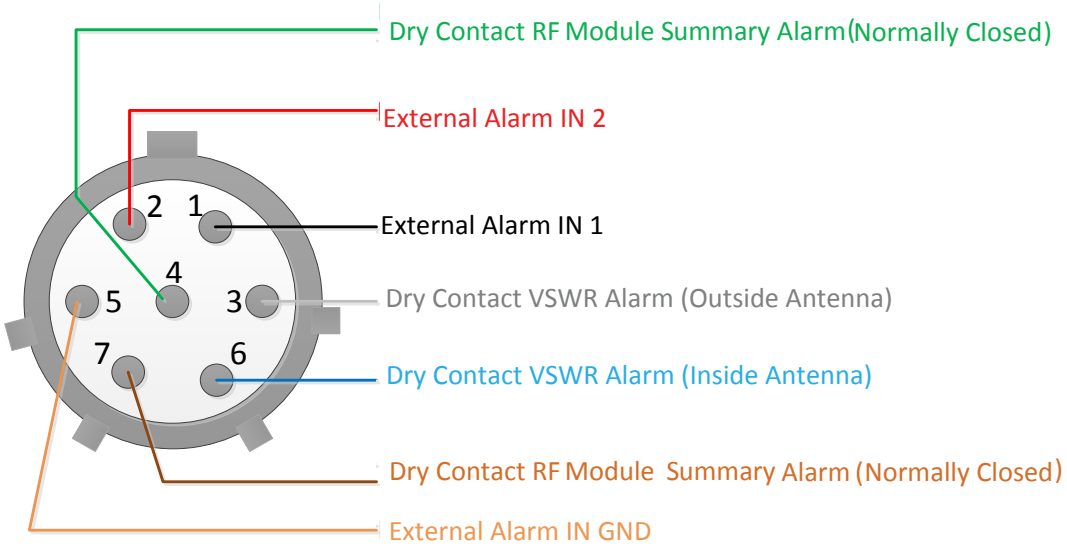

Male Alarm Connector Pinout Diagram

Pin Number	Definition	Color
1	External Alarm IN 1	Black
2	External Alarm IN 2	Red
3	Dry Contact VSWR Alarm (Outside Antenna)	White
4	Dry Contact RF Module Summary Alarm (Normally Closed)	Green
5	External IN GND	Orange
6	Dry Contact VSWR Alarm (Inside Antenna)	Blue
7	Dry Contact RF Module Summary Alarm (Normally Closed)	Brown

# BDA Interface & Connections

---

## 2.6 Ethernet Interface (A4)



Female Ethernet Port (RJ-45) on BDA  
Hidden Under Yellow Cap



Male Ethernet Connector  
For Data Transfer

## 2.7 USB Interface

The USB connector is on top of the Guardian3 unit, below the DIP switches, as shown below.



# BDA Interface & Connections

As shown, the NEMA housing must be open to gain access to this port. The interface is used to initialize network connections using a computer. Be sure to unplug the USB cable after the network initialization is completed.

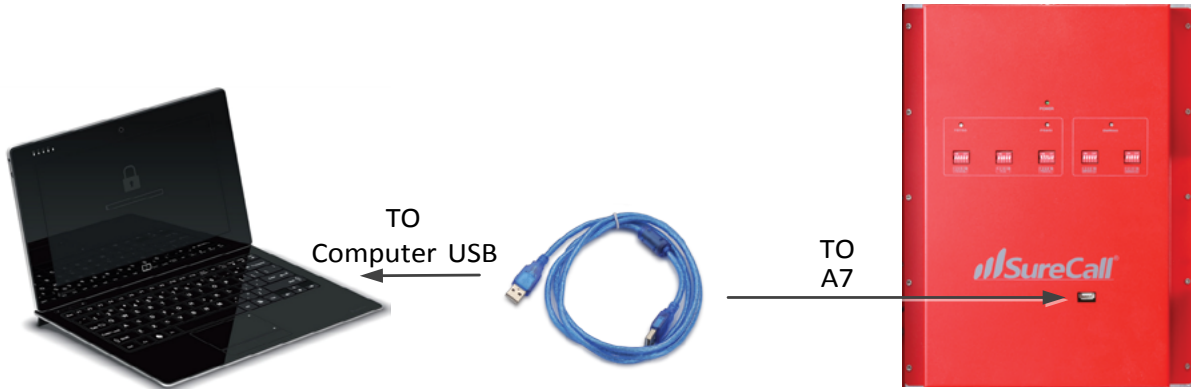

## 2.8 Alarm LEDs (A8)

	Status	Description	Note
POWER	Green ON	Normal	
	OFF	Missing Power	
ALARM1	Red ON	NO	Reserved for: Battery undervoltage Power AC off Battery charge
	OFF	Normal	
ALARM2	Red ON	RF Module Summary: Over-current Osc alarm Over-power	
	OFF	Normal	
ALARM3	Red ON	VSWR Alarm	
	OFF	Normal	

# Planning the Installation

---

## CHAPTER 3: PLANNING THE INSTALLATION

---

### 3.1 Installation Overview

Typically, a BDA installation follows these steps:

1. Decide what type of exterior antenna to use, and where to mount it. You will use either an omnidirectional antenna, mounted vertically, or a directional Yagi antenna, pointed directly at the radio tower (line of sight). The antenna will normally be mounted on the wall or roof of the building with the strongest signal. A grounded lightning protector is required between the exterior antenna and the BDA.
2. Decide where to mount the interior antenna(s), being sure to take separation requirements into account. Long, narrow spaces benefit most from directional flat-panel antennas, while more square spaces benefit more from omnidirectional dome antennas.
3. Decide where to mount the BDA. This should be in a secure indoor location near a grounded power source.
4. Decide where to route the cables between the exterior antenna and the BDA and between the BDA and interior antennas.
5. Install the antennas as described in their respective Installation Manuals.
6. Route the cables to the BDA location.
7. Install the BDA as described in this manual.
8. Power on the BDA and perform configuration and testing explained in Chapter 5.

Important Installation Safety Precautions:



**CAUTION: FAILURE TO PROPERLY INSTALL A LIGHTNING PROTECTOR CAN RESULT IN DAMAGE TO THE BDA, ANTENNAS, AND WIRING.**

- Some components may be heavy and/or bulky. Always use proper lifting and carrying techniques when handling components, especially when working on a ladder, roof, or other area with a fall hazard.
- The exterior antenna must not be co-located or operating in conjunction with any other antenna.
- Always use a properly installed SureCall lightning protector between the exterior antenna and the BDA.
- Always power off the BDA before working on the roof of the building, or anywhere in close proximity to the external antenna.

- Allow at least 24 inches (60cm) of separation between interior antennas and humans or animals.
- Allow at least 24 inches (60cm) of separation between exterior antennas and all persons.
- Comply with all antenna separation requirements to prevent signal oscillation.



**CAUTION: SIGNAL OSCILLATION CAN CAUSE RADIO INTERFERENCE WITH RADIO TOWERS AND RESULT IN CIVIL AND/OR CRIMINAL PENALTIES.**

### 3.2 Exterior Antenna

You may use either an omnidirectional antenna that covers flat areas with no obstructions or a directional Yagi antenna to point directly at the tower. The omnidirectional antenna receives and transmits signals over a horizontal 360-degree circle. The Yagi antenna receives and transmits signals over a focused area and must be aimed directly (line of sight) toward the radio tower that provides the strongest signal to the building.

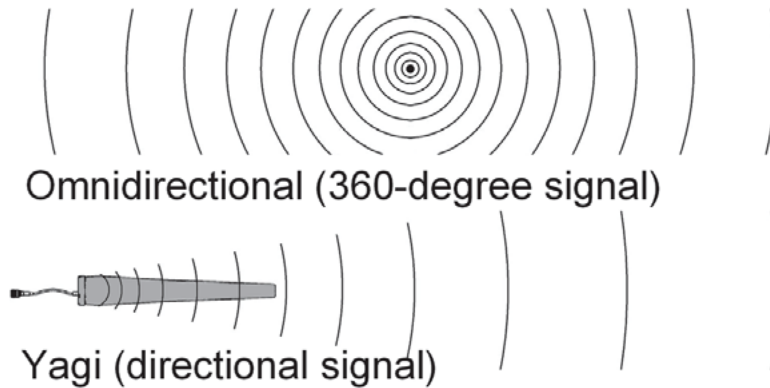

The exterior antenna and mast (if any) must be mounted in a location that meets all of the following criteria:

- Best signal strength.
- Not co-located with other antennas or used in conjunction with other antennas.
- Away from all power lines.
- At least 6 ft. from lightning rod antennas.
- At least 24 in. from any person.

# Planning the Installation

These distances are general guidelines only. Refer to the applicable building and electrical codes in your area to determine specific local requirements.

## 3.3 Interior Antennas

You may use any combination of omnidirectional (dome) and/or directional (flat panel) interior antennas to obtain balanced signal strength throughout the structure.

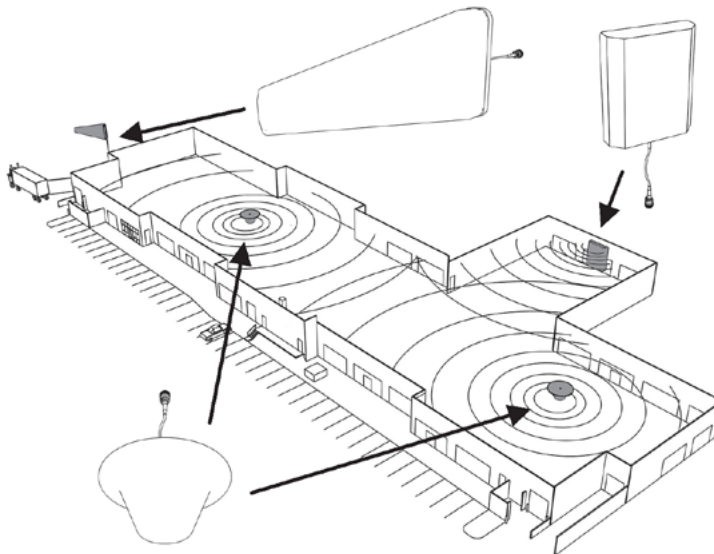

Dome antennas provide 360-degree hemispherical coverage suitable for mostly square areas, while flat panel antennas provide a focused zone of coverage suitable for long narrow areas. The example above uses two dome antennas and one panel antenna to provide full coverage

Keep in mind that floor structures in multistory buildings can cause significant signal loss, which means that you may need to install interior antennas on more than one floor. Here is an example of a multistory installation:

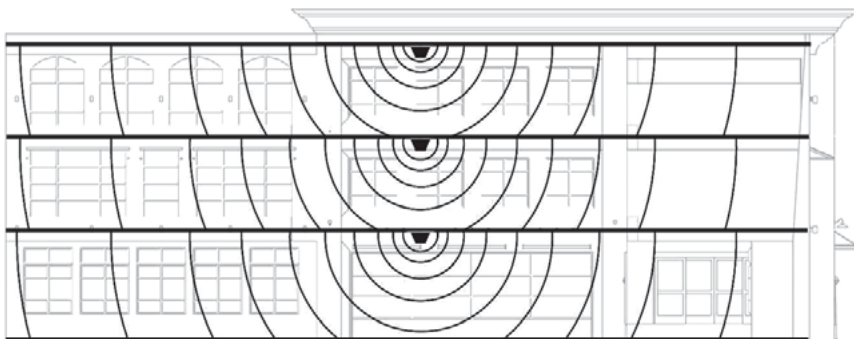



Note: You may not need antennas on every floor of a multistory building, depending on factors such as building material, BDA gain, etc.

### 3.4 Antenna Separation

Proper antenna separation prevents signal oscillation (feedback) that can interfere with the radio tower. Separation is measured in a straight line from the exterior antenna to the closest interior antenna. The closest allowable distance depends on a number of factors, such as BDA gain level, building material, etc. Recommended separation distances are:

Amplifier gain	Min. separation (ad)
40 dB	5'-6'
45 dB	15'-20'
50 dB	50'
55 dB	60'
65 dB	75-80'
70 dB	100'
75 dB	100'-120'
80 dB	120'-180'

Vertical separation is more important than horizontal separation. If you are unable to obtain the required separation horizontally, try raising the exterior antenna. You may also try reducing the BDA gain as described in Chapter 5 of this manual.

# Planning the Installation

## Antenna Safety Precautions:

You can mix and match dome and directional antennas as needed to obtain proper coverage throughout the building or area where you need to boost the signal. If you use a Yagi exterior antenna, you should normally aim it away from all interior antennas, regardless of separation, to prevent oscillation.

### Antenna Aiming

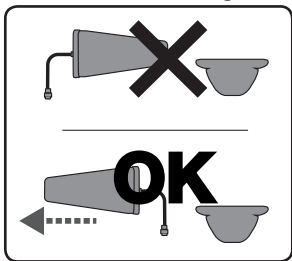

CAUTION: SIGNAL OSCILLATION CAN CAUSE RADIO INTERFERENCE WITH RADIO TOWERS AND RESULT IN CIVIL AND/OR CRIMINAL PENALTIES.

## 3.5 Locating the BDA

Select an indoor location for the BDA that meets the following criteria:

- Wall or ceiling mounts are both acceptable.
- Near a properly grounded 110VAC outlet.
- Avoid in a tightly enclosed or overly hot spaces.
- All power and warning lights are easily visible.
- You can use the shortest cables to connect all antennas.

## 3.6 Accessories

The final step in the planning process is to make sure you have all of the necessary accessories to complete the installation. You will need all of the items listed in Chapter 1 of this manual plus some or all of the following:

- Cable clips: Use these to secure the cables to interior and exterior walls/ceilings.
- Appropriately rated sealant/caulking: Use this to waterproof the opening where the cable from the exterior antenna enters the building, if needed.
- Hand and/or power tools: As needed to complete the installation.
- Personal Equipment (PPE): Use all PPE required by local codes and/or best practices to help ensure personal safety during installation.



CAUTION: YOU ARE RESPONSIBLE FOR ENSURING THAT THE INSTALLATION MEETS ALL APPLICABLE CODES.

Note: You may need to obtain a permit from your local building department to install the BDA and antennas. Check your local building and/or electrical codes.

### 3.7 Need Help?

If you need help planning your installation, contact a qualified installer, the reseller who supplied you with the BDA, or SureCall:

Call: 1-888-365-6283, 7 a.m. to 5 p.m. PST, Monday – Friday

Email: [support@surecall.com](mailto:support@surecall.com)

## CHAPTER 4: INSTALLATION

---

### 4.1 Soft Installation

Perform a “soft” installation of all components to test signal coverage and oscillation before making the installation permanent. Avoid making holes or other permanent attachments during this phase. Refer to Chapter 5 for configuration and testing instructions. Proceed with final installation once configuration and testing are complete.

### 4.2 Exterior Antenna

Mount the exterior antenna in the location you selected when planning. Follow all of the instructions included with the antenna to ensure that your installation is done properly. Here are a few reminders and essential steps:

- An omnidirectional antenna is always mounted vertically.
- A Yagi antenna is mounted horizontally, and aimed at the desired radio tower (line of sight).
- Mount the antenna.
- Connect a length of cable to the antenna and tighten until hand-tight.
- Run the cable along the planned route.
- Install a properly grounded SC-LP lightning protector.
- Seal any holes you make in the outside of the building with caulking or sealant.



WARNING: FAILURE TO EXERCISE CAUTION WHEN WORKING IN HIGH AREAS COULD CAUSE A FALL AND PERSONAL INJURY.



WARNING: DO NOT TOUCH ANY LIVE ELECTRICAL WIRES OR ALLOW THE ANTENNA OR CABLING TO TOUCH ANY LIVE ELECTRICAL WIRES.



CAUTION: AVOID AIMING A YAGI ANTENNA TOWARD ANY INTERIOR ANTENNA.

## 4.3 Interior Antennas

Mount the interior antenna(s) in the location(s) you selected when planning. Follow all instructions included with the antenna(s) to ensure the installation(s) are done properly.

Here are a few reminders and essential steps:

- Dome antennas are mounted on the ceiling as close to the center of the desired coverage area as possible, domed (convex) side pointing down.
- Flat panel antennas should be wall-mounted as close as possible to the center of the wall, or at one end of long narrow space.
- Mount the antenna.
- Connect a length of cable to the antenna and tighten until hand-tight.
- If you are installing multiple antennas, run the cable to the splitter location and connect the cable to one of the outputs on the splitter.
- Connect another length of cable to the input side of the splitter (if used) and run this cable to the BDA location.
- It is important to keep the cable runs equal or use taps to ensure a harmonious install.



CAUTION: VERIFY THAT ALL INTERIOR ANTENNAS MEET THE SEPARATION REQUIREMENTS DESCRIBED IN THE PREVIOUS CHAPTER, AND THAT NO ANTENNA IS AIMED TOWARD THE EXTERIOR ANTENNA.



CAUTION: DO NOT CONNECT AN INTERIOR ANTENNA TO THE SPLITTER INPUT.

# Installation

---

## 4.4 Mounting the BDA

Mount the Guardian3 QR as follows:

- Verify that the selected location meets all criteria described in the previous chapter.
- Mount a 24 inch x 24 inch x 3/4 inch thick sheet of plywood on top of sheetrock, secured into wall studs where the NEMA housing is to be placed. The plywood should be flush against wall.
- Once the plywood is secure, attach the NEMA housing to the plywood base using the screws provided. In most installations, the housing will be oriented so the I/O ports are facing down.
- Connect the outdoor antenna cable to the signal booster connector port marked OUTSIDE and tighten the connection.
- Connect the outdoor antenna cable to the signal booster connector port marked INSIDE and tighten the connection.



CAUTION: DO NOT POWER ON THE BDA UNTIL INSTRUCTED TO DO SO.



CAUTION: NEVER POWER ON THE BDA WHEN ANY ANTENNAS ARE DISCONNECTED AS THIS COULD DAMAGE THE BDA.

## CHAPTER 5: CONFIGURATION & TESTING

### 5.1 Powering on the BDA

1. Make sure the exterior and interior antenna cables are firmly connected to their corresponding ports on the NEMA-4 enclosure.
2. Plug a surge suppressor into a grounded 110VAC wall outlet.
3. Plug the AC end of the power adapter (supplied with your BDA) into the surge suppressor.
4. Plug the DC end of the power adapter into the Power port on the NEMA enclosure.
5. Verify that the green Power light is illuminated.
6. When the booster is turned on, the band lights will flash red and yellow for approximately 10 seconds.



CAUTION: ONLY USE THE POWER SUPPLY INCLUDED WITH THE BDA. USE OF ANOTHER POWER SUPPLY COULD DAMAGE THE BDA AND/OR POWER SUPPLY.



CAUTION: DO NOT PROCEED BEYOND THIS POINT UNTIL THE BDA IS POWERED ON AND NO RED WARNING LIGHTS ARE ILLUMINATED.

### 5.2 DIP Switch Configuration

By default, your booster ships with all DIP switches turned OFF to provide maximum gain in all channels. This should always be your starting point whenever installing or reinstalling the booster. When the booster is turned on, the band lights will flash red and yellow for approximately 10 seconds. The following diagrams and notes explain how to interpret, and use, these switch banks.

# Configuration and Testing

## DIP switch organization

- PS 700 DL DIP switches control 700 band downlink
- PS UL DIP switches control 700 band and 800 band uplink
- PS 800 DL DIP switches control 800 band downlink
- SMR 900 UL DIP switches control 900 band uplink
- SMR 900 UL DIP switches control 900 band downlink

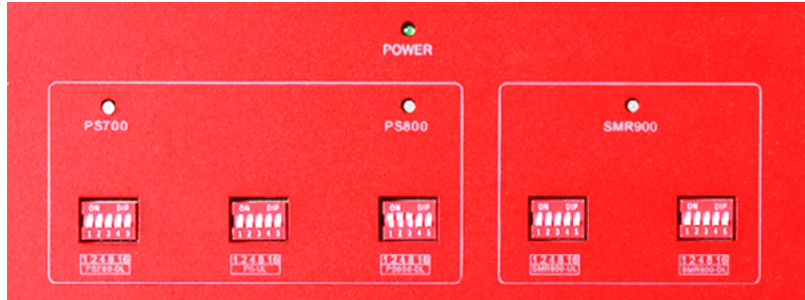

Switches should be OFF unless red flashing lights occur for a channel or channels. Red flashing lights indicate the system has detected oscillation for the corresponding channel(s). They then turn off if adjustments are not made. When adjusting the booster, full power is not always the best option. Your goal is to obtain a usable signal in as many areas of the building as possible.



## Additive combination effects:

- Switch 1 (1 dB) + Switch 2 (2 dB) = 3 dB attenuation
- Switch 1 (1 dB) + Switch 2 (2 dB) + Switch 3 (4 dB) = 7 dB attenuation
- Switch 1 (1 dB) + Switch 2 (2 dB) + Switch 3 (4 dB) + Switch 4 (8 dB) = 15 dB attenuation
- Switch 1 (1 dB) + Switch 2 (2 dB) + Switch 3 (4 dB) + Switch 4 (8 dB) + Switch 5 (16 dB) = 31 dB attenuation



# Configuration and Testing

A few practical examples:

- Turning all switches OFF = 0 dB attenuation (booster is at full gain).
- Turning ON switch #1 in a bank = 1 dB attenuation (booster maximum gain is reduced by 1 dB).
- Turning ON switches #1, 3, and 5 in a bank = 1+4+16 dB attenuation = 21 dB attenuation. For example, in an 80 dB booster, the selected channel is reduced to 59 dB (80 dB -21 dB).
- Turning ON all switches in a bank = 1+2+4+8+16 dB attenuation = 31 dB attenuation. For example, in an 80 dB booster, the selected channel is reduced to 49 dB (80 dB-31 dB).

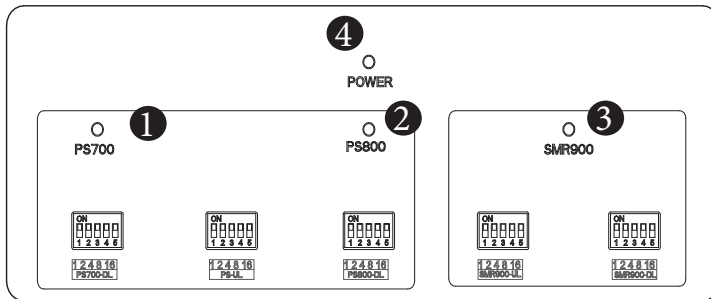

When the BDA is powered on, the green Power Light (4) should illuminate.

- If any of the bands are oscillating, the corresponding band lights (1,2,3) will flash red and that band will eventually shut down if adjustments are not made.

Note: In general, the uplink and downlink DIP switches should be set identically but this is not always the case.

## 5.3 Band LED Conditions

This section will help you interpret the LED indicators on your Guardian3 QR. But first, here are a few configuration and testing points to keep in mind:

- When choosing a location for the outside antenna, a minimum signal reading of -100 dB is needed. A signal in the -70 dB to -90 dB range is recommended for best performance. A signal stronger than -70 dB may cause the affected frequency bands to stop amplifying.
- The booster gain dials should be at maximum level unless the control light for a specific frequency band is flashing red or red-yellow. In either case, try increasing the antenna separation between the inside and outside antennas as much as possible first, and then restarting the booster.
- Avoid setting the gain below 35 dB, as this could cause the affected frequency band to stop amplifying.

# Configuration and Testing

## LED INDICATIONS

LED Color	LED Condition	Resolution
Yellow	Solid	The frequency band is not in use. Eventually, the band will enter sleep mode. When the light is off, it means things are normal, and that the band is active.
Yellow	Flashing	The Automatic Gain Control (AGC) is self-adjusting. This occurs during normal operation.
Red	Flashing	The booster is receiving too much signal. Can cause the affected band to automatically turn off. If this happens: <ol style="list-style-type: none"><li>1. For kits using an OMNI outside antenna, relocate the outside antenna to a location where the signal is weaker.</li><li>2. For kits using a YAGI outside antenna, turn the antenna in short increments away from the signal source.</li><li>3. Increase the separation between antennas (more vertical separation works best).</li><li>4. Add an inline attenuator to the cable connected to the Outside port on the booster.</li></ol>
Red	Solid	The associated frequency band is off. If the red light flashes for a long time (caused by too much signal), and then turns solid red, it means the associated frequency band has been turned off. This will happen if the gain dial for that frequency band has been turned all the way down.
Yellow/ Red	Flashes alternating colors	Self-oscillation has been prevented. Try this: <ol style="list-style-type: none"><li>1. Increase the separation between the inside and outside antennas. If your booster kit uses two directional antennas (example: outside Yagi antenna and inside panel antenna), ensure that they are facing away from each other.</li><li>2. If the condition continues, lower the dB gain setting in small increments until the light turns off or flashes yellow.</li></ol>

Refer to your Sentry Monitoring Software for more information about LED codes. Meanwhile, if you have any questions during setup, please reach out to our U.S.-based support technicians:

Call: 1-888-365-6283

Email: [support@surecall.com](mailto:support@surecall.com)

Or, chat: [www.surecall.com](http://www.surecall.com) , 7:00 am – 5:00 pm PST, Monday – Friday

### 5.4 Testing & Troubleshooting

Once the booster is powered on (and no Warning lights are on), walk around the area to assess the voice and/or data signal in representative variety of locations. Refine the antenna locations and/or gain levels as needed, and then complete the permanent installation when you are confident the system will perform well.

A few tips and some perspective:

- It's not realistic to expect full reception everywhere in the building.
- As a general rule, increasing gain by 6dB doubles the coverage distance of the interior antennas. Start at the lowest gain and increase gradually as needed.
- If one or more red Warning lights comes on, it indicates there is oscillation in that band and adjustments are needed

# Alarm Interface, Definitions & Conditions

- If you can't get the coverage reasonably well-balanced, you may need to install an additional interior antenna and/or a different type of interior antenna and/or relocate interior antennas.

## CHAPTER 6: ALARM INTERFACE, DEFINITIONS & CONDITIONS

### 6.1 Interface & Diagrams

Note: For proper operation, the COM pin needs to be connected to the NO pin. Do not connect the COM pin to the NC pin, or this will trigger the alarm.

The Alarm interface is defined below:

Pin	Definition	Note
1	NO	Normal open
2	COM	Common
3	NC	Normal close
5	GND	Ground connection
9	+12V	Optional 12 VDC (250mA) auxiliary output

When the device is working properly, the COM pin is connected to the NO pin. When the device is not normal, the COM pin is connected to the NC pin. When the COM pin is connected to the NC pin, the external alarm device will trigger the alarm.

An alarm is triggered by the following conditions:

- Shutdown caused by oscillation
- Shutdown caused by overload
- Irregular current
- No power

### 6.2 Summary Alarm Trigger Conditions

The Summary Alarm (pin 4 and pin 7) is triggered under one (or more) of the following conditions:

- PA shutdown causing by oscillation
- PA shutdown causing by RF Power overload
- Repeater power OFF
- Repeater current is abnormal

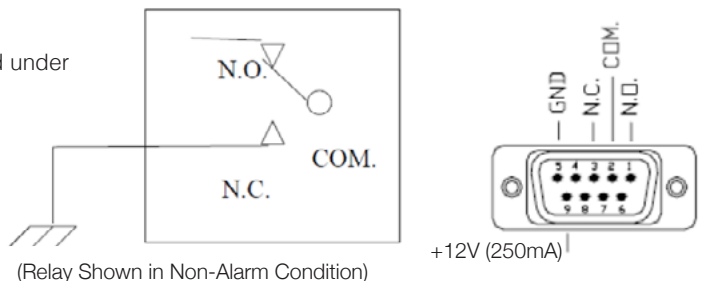

# Alarm Interface, Definitions & Conditions

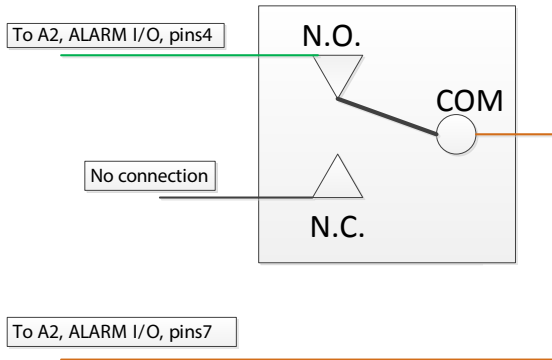

Relay Shown In Non-Alarm Condition

Dry Contact RF Module Summary in Non-Alarm  
Relay connection Fig. in Non-Alarm Condition  
Contacts pins4 of A2, pins7 of A2 CLOSE

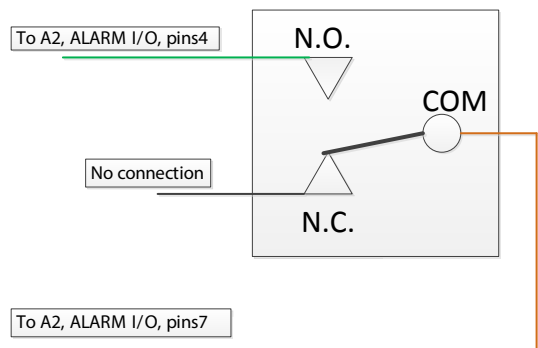

Relay Shown In Alarm Condition

Dry Contact RF Module Summary in Alarm  
Relay connection Fig. in Alarm Condition and Power OFF  
Contacts pins4 of A2, pins7 of A2 OPEN

## Load Restrictions

### Alarm Dry Contact Output Restrictions

- Maximum switching voltage: 125 VAC, 60 VDC
- Maximum switching current: 1A

### External Alarm Input Restrictions

- Maximum repetitive reverse voltage: 28 V
- Impedance load: 470 Ohm

# Alarm Interface, Definitions & Conditions

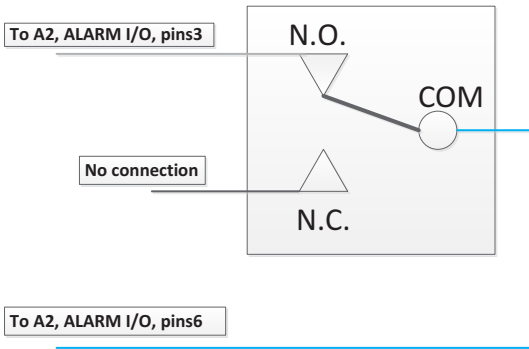

Relay Shown In Non-Alarm Condition

Dry Contact VSWR in Non-Alarm  
 Relay connection Fig. in Non-Alarm Condition  
 Contacts pins3 of A2, pins6 of A2 CLOSE

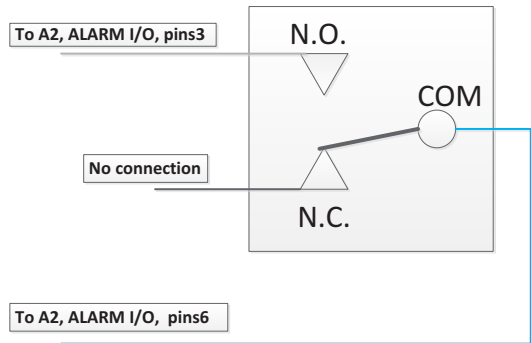

Relay Shown In Alarm Condition

Dry Contact VSWR in Alarm  
 Relay connection Fig. in Alarm Condition  
 Contacts pins3 of A2, pins6 of A2 OPEN

## 6.3 Alarm LED Descriptions

	Status	Description	Note
POWER	Green ON	Normal	
	OFF	Missing Power	
ALARM1	Red ON	NO	Reserved for: Battery under-voltage Power AC off Battery charge
	OFF	Normal	
ALARM2	Red ON	RF Module Summary: Over-current Osc alarm Over-power	
	OFF	Normal	
ALARM3	Red ON	VSWR Alarm	
	OFF	Normal	

# Sentry Configuration & Monitoring

---

## CHAPTER 7: SENTRY CONFIGURATION & MONITORING

---

### 7.1 Sentry Software Introduction

SureCall's Sentry is a revolutionary advancement in signal-booster management. It aids in the installation, optimization, and ongoing management of your Guardian3 QR BDA. It provides installers with tools for seamless system configurations, and it helps pinpoint malfunctions due to unforeseen changes in the amplifier landscape, such as new towers or repeater systems. Sentry also notifies installers or end users about various parameters via email. Features include:

- Quick notification about booster changes and over-power situations.
- Allows offsite monitoring and adjustments related to booster performance, such as uplink, downlink or bands.
- Helps optimize installations by monitoring and identifying the strongest signal strength available.

### 7.2 Software Installation

To install and configure the server, follow these steps:

- Get the SureCall Sentry software from your device supplier, or download the software here: <http://www.surecall.com/product/Sentry.html>.
- Install the software using the steps outlined below.
- Configure the server to a static IP or public IP address.
- In order to function on the network correctly, the server and the Guardian3 QR device must be (a) on the same Local Area Network, or (b) the server must be the front end to the device.
- Use appropriate security software for safe and reliable operation when connected to a network.
- All device and user information will be stored on the computer.

Double-click [ServerSentrySetup\(V1.5\).exe](#) to start the installation, which takes you to Welcome screen shown below.

**Note: To avoid install glitches, we recommend you close all other Windows programs running on your computer before proceeding.**

After you have shut down other programs, click Next, which will take you to the User Information screen shown below. This is where you'll enter user information. It may be you as the installer, or you may be setting this up for someone else who will be monitoring the system on an ongoing basis.

# Sentry Configuration & Monitoring

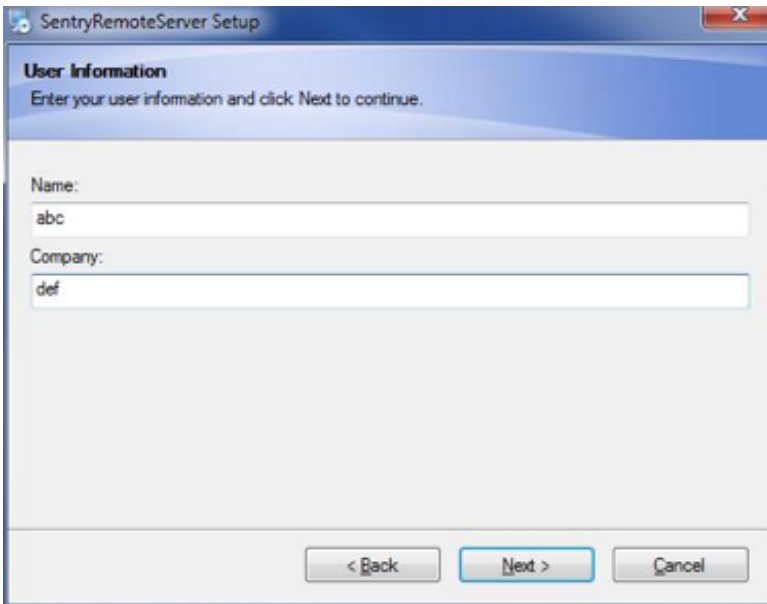

When you have completed the fields, click Next to proceed to the Installation Folder screen as shown below. In most situations, the default choices and information provided here work fine. Click Next to continue.

# Sentry Configuration & Monitoring

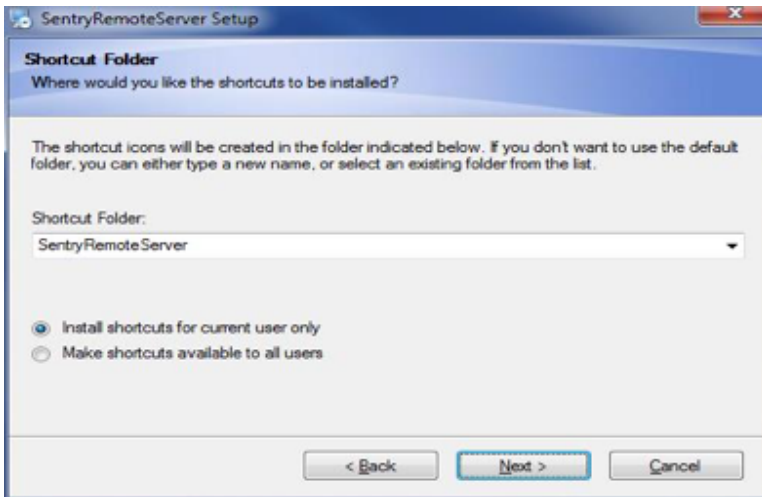
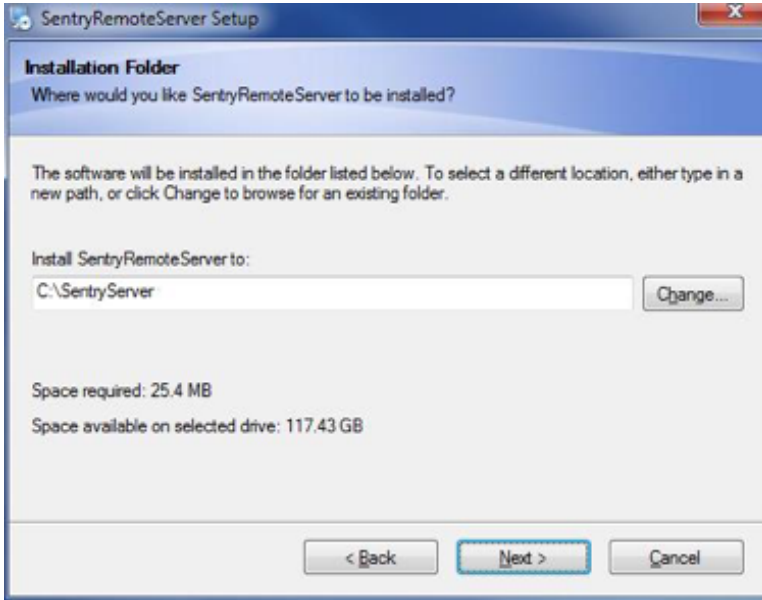

Normally, the defaults shown above (applies to current user only) work fine. Click Next to continue. This will take you to the Ready to Install screen as shown below.



# Sentry Configuration & Monitoring

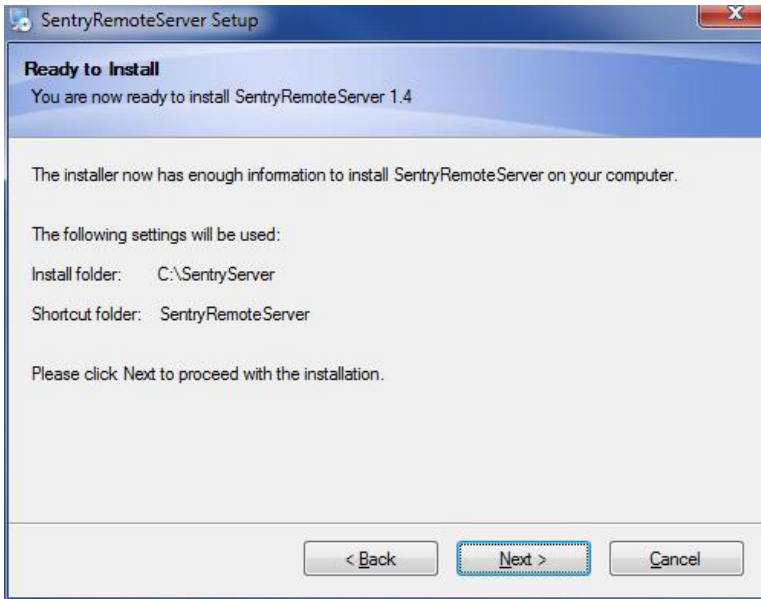

The above screen confirms the installation folder and shortcut folder where you can access the Sentry software. Click Next to proceed with the installation. The software will now install. A launch icon will be placed on your Desktop. When the process is complete, you'll should see the Installation Successful screen as shown below. This verifies that the Sentry Remote Server software installation is complete.

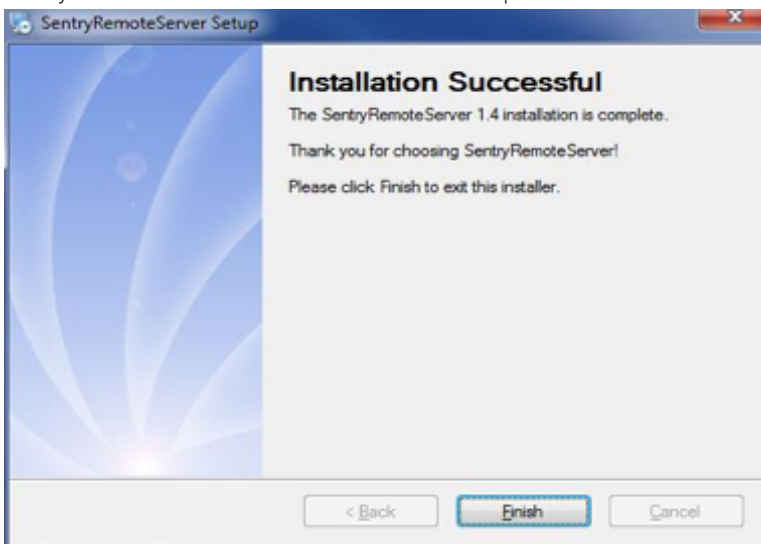

Click Finish. Your Sentry installation is done. Proceed to the next section, Hardware Installation.

# Sentry Configuration & Monitoring

## 7.3 Hardware Installation

Once the Sentry software is installed, you can proceed to connect and configure the Guardian3 QR BDA.

To install the hardware, first complete the following steps:

- **USB Connection.** Use a USB cable to connect your computer directly to the Guardian3 QR USB port. The USB connection on the Guardian 3 QR is accessible by opening the NEMA-4 enclosure. The port is on top of the unit inside the enclosure, as shown below.
- **Ethernet Connection.** Plug the Ethernet cable into the yellow-capped socket on the bottom of the NEMA-4 enclosure, labeled Ethernet. The other end of the Ethernet cable goes to the network server or network switch on the LAN.

Once the connections are made, power on the Guardian3 QR BDA.

Register an account: Before you install the hardware, you'll first need to register an account. Connect your computer to the network where the Guardian3 QR Ethernet connection was made. A secure LAN connection is important because it will allow the computer to "see" the Guardian3 QR device on the network.

Start the Sentry client application by clicking on the shortcut that resulted from installing the software. You will see the screen below:

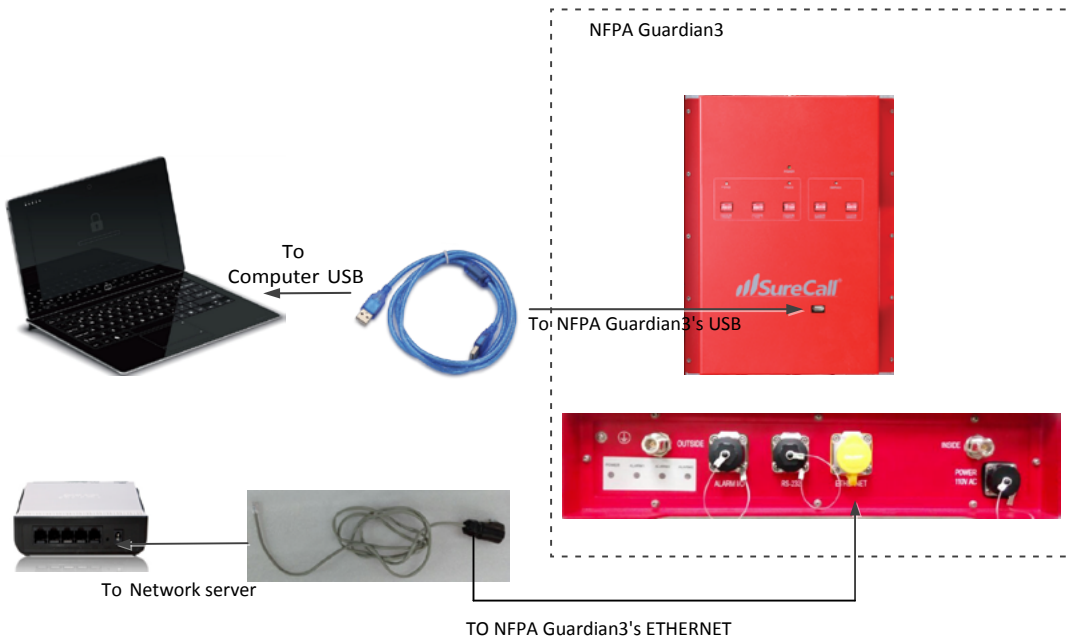

# Sentry Configuration & Monitoring

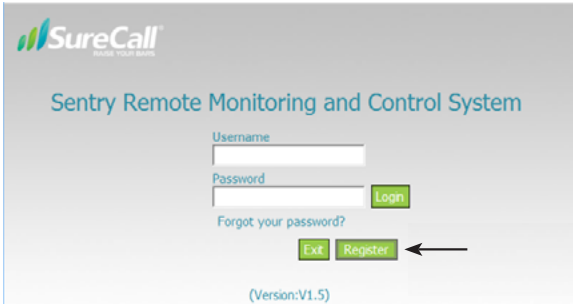

Click Register and you'll see the following screen, prompting you to enter the local Server IP address.

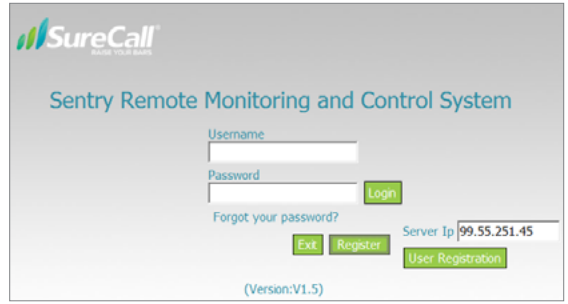

Enter the local Server IP, or you can use SureCall's server IP: 99.55.251.45.

Enter a User Name, Password, E-mail, and User Phone in the fields provided. Then click Register to proceed. You will see the Login screen again, as shown in the next screen.

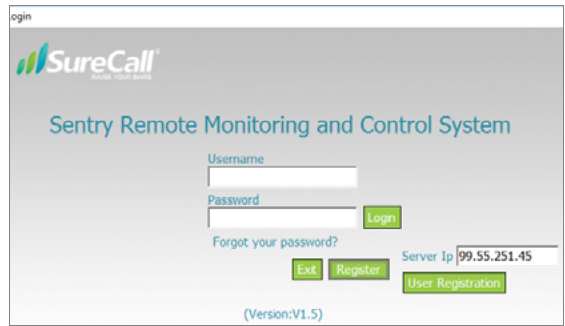

In the fields provided, enter the Username and Password that you just registered on the system. This will enable you to proceed to device configuration, as explained in the steps below:

# Sentry Configuration & Monitoring

Register the Device. Connect the Guardian3 QR device to the networked client computer with a USB cable as described in the previous section. Make sure the server is also linked to the computer. Select a serial port and click Open, as shown in the Add Booster screen below.

Complete device registration as described below:

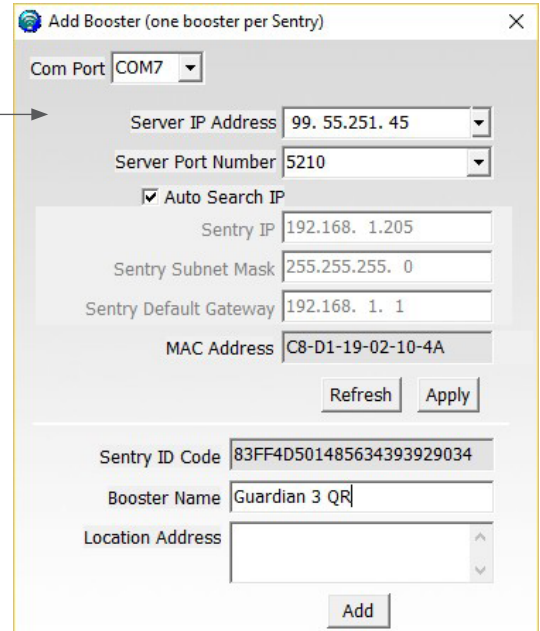
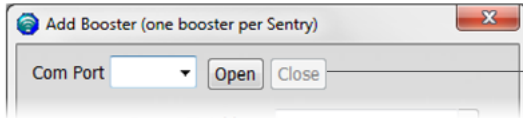
A detailed screenshot of the "Add Booster (one booster per Sentry)" configuration window. The "Com Port" is set to "COM7". The "Server IP Address" is "99.55.251.45" and the "Server Port Number" is "5210". The "Auto Search IP" checkbox is checked. Below it, the "Sentry IP" is "192.168.1.205", "Sentry Subnet Mask" is "255.255.255.0", and "Sentry Default Gateway" is "192.168.1.1". The "MAC Address" is "C8-D1-19-02-10-4A". There are "Refresh" and "Apply" buttons. At the bottom, the "Sentry ID Code" is "83FF4D501485634393929034", the "Booster Name" is "Guardian 3 QR", and the "Location Address" field is empty. An "Add" button is at the bottom right.

- Click Refresh to query device parameters
- Enter a name in the Booster Name field
- Enter the location in the Location Address field (optional)
- Click Add to register the device on the server
- Keep in mind that only the registered user is authorized to see/operate the added device.

Using the same screen as before, configure the device according to the steps below.

## 7.4 Configuring the Booster System

### Configure the Device.

- Select a serial port and click Open.
- Click Refresh to query device parameters.
- Click on the drop-down menu and select a server IP address and port number to make sure the device can be connected to the server.
- Dynamic IP is available by checking Auto Search IP function, OR...
- ...OR enter IP parameters manually, if the device needs a static IP.
- Click Apply to finish the configuration.

The following summary screen appears if the booster connects to the server successfully:

# Sentry Configuration & Monitoring

Type: Public NFPA Name: hhh Address: hhh

Band	Channel	Attenuation	Manual Attenuation	Automatic Gain Control Attenuation	Gain	Output Power	Outside Signal Strength	Uplink/ Downlink Status	Band On/ Off	Over Power	Oscillation	Manual Shut Off	Operation Power	Current Status
PS700	Uplink 788-805M	0 dB	0 dB	0 dB	76 dB	0 dBm		Active	ON	Normal	Normal	Normal	6 W	Normal
	Downlink 758-775M	0 dB	0 dB	0 dB	80 dB		-78 dBm	ON	ON	Normal	Normal	Normal	6.8 W	Normal
PS800	Uplink 806-824M	0 dB	0 dB	0 dB	76 dB	0 dBm		Active	ON	Normal	Normal	Normal	6 W	Normal
	Downlink 851-869M	0 dB	0 dB	0 dB	80 dB		-78 dBm	ON	ON	Normal	Normal	Normal	5.8 W	Normal
SMR900	Uplink 896-901M	0 dB	0 dB	0 dB	76 dB	-10 dBm		Active	ON	Normal	Normal	Normal	6.1 W	Normal
	Downlink 935-940M	0 dB	0 dB	0 dB	80 dB		-85 dBm	ON	ON	Normal	Normal	Normal	6.1 W	Normal

Sentry Software Version SC M3-MONITOR V1.3

Sum Power 49.2 W Device Status Normal Outdoor Antenna Normal Indoor Antenna Normal

Battery Connection Normal Battery Capacity Normal AC Power Normal Battery Charger Normal

Out1 Alarm Normal Out2 Alarm Normal

## Column Definitions:

- Attenuation: Manually adjusted attenuation via software.
- Manual Attenuation: Manually adjusted attenuation using controls on the device.
- Automatic Gain Control: Automatically adjusted attenuation from excessive signal.
- Gain: Current gain.
- Output Power: Current power.
- Outside Signal Strength: Strength of input signal.
- Uplink/Downlink Status: RF band status: Sleep, Active, OFF.
- Over Power: Over-power alert status: Red=Alert; Green=Normal.
- Oscillation: Oscillation-alert status: Red=Alert; Green=Normal.
- Over Attenuation: Manual over-attenuation status: Red=Alert; Green=Normal.
- Current Status: Over-current alert status: Red=Alert; Green=Normal.
- Operation Power: Single RF band power.

## Other Definitions:

- Booster Connection: Booster and Sentry module Connection. Red=Disconnection; Green=Normal.
- Sum Power: Sum power of the device
- Device Status: RF status of the device. Red=Alert; Green=Normal.
- Uplink VSWR: Uplink VSWR status. Red=Alert; Green=Normal.

# Sentry Configuration & Monitoring

- Inside antenna VSWR status. Red=Alert; Green=Normal.
- Battery Connection: Battery connection status. Red=Disconnection; Green=Normal (reserved function).
- Battery Capacity: Battery capacity status. Red=Low; Green=Normal (reserved function).
- AC Power: AC-power status. Red=Off; Green=Normal (reserved function)
- Battery Charger: Battery charging status. Red=Charging; Green: Normal (reserved function)
- Out1 Alarm, Out2 Alarm: Out-alert status. Red=Alert; Green=Normal.



NOTE: BOTH THE MANUALLY ADJUSTED ATTENUATION BY DEVICE AND BY SOFTWARE CANNOT EXCEED 25 DB.

Another feature is E-mail Alert, meaning that the user will receive an e-mail if an alert occurs.

Modify Booster Information. To modify the booster information, right click to access a pop-up menu with the following additional options. Select Edit Booster Info to proceed.

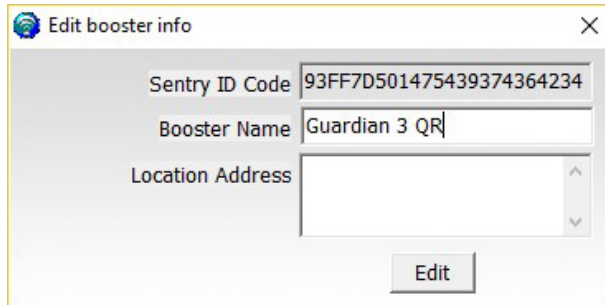
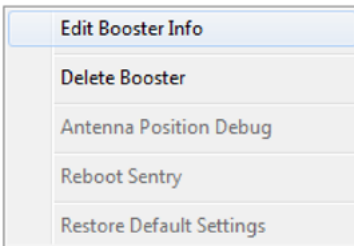

# Sentry Configuration & Monitoring

Delete Booster. To delete a booster, right click on the summary screen again to access a pop-up menu with additional options, and then select Delete Booster.

You will see a confirmation screen as shown below. Click Yes to proceed.

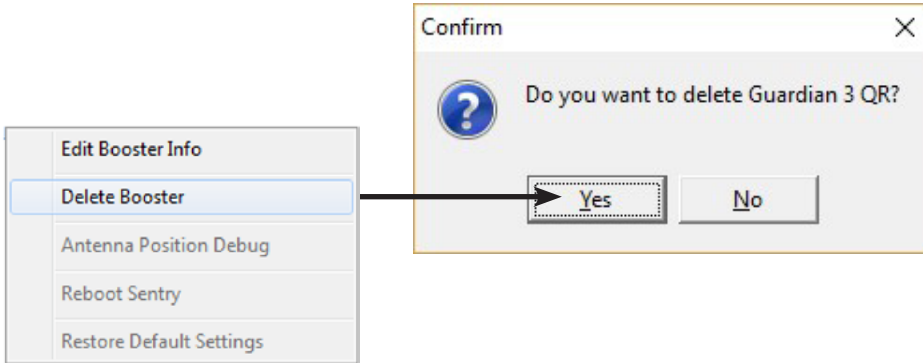

Password and E-mail Management: In the Tools pull-down menu, you can change your account information, including your password, or the e-mail address for status reports. Roll over the Accounts heading and click on Modify Password/E-mail to access this feature.

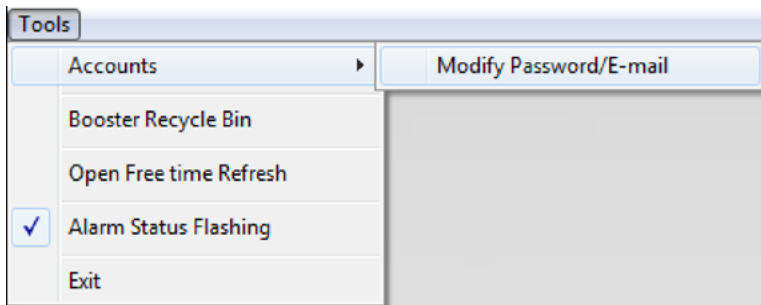

# Sentry Configuration & Monitoring

To modify your password, type in the requested information shown below and click on Modify.

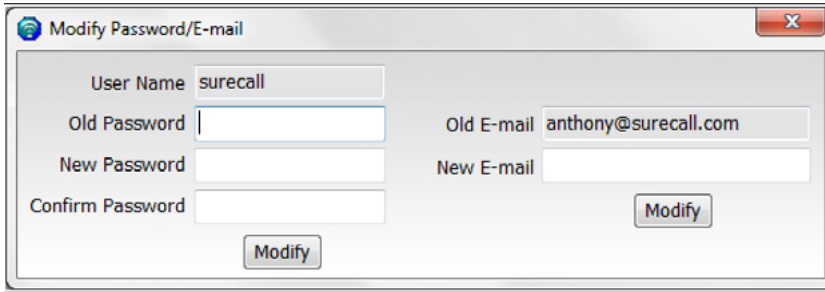

Modify Password/E-mail

User Name: surecall

Old Password: [ ]

New Password: [ ]

Confirm Password: [ ]

Old E-mail: anthony@surecall.com

New E-mail: [ ]

Modify

Modify

To change the e-mail address where alerts go, enter a new e-mail as shown above and click on Modify.



NOTE: IF YOU FORGET YOUR PASSWORD, CLICK FORGOT MY PASSWORD ON THE LOGIN PAGE. THE PASSWORD WILL BE SENT TO YOUR E-MAIL ADDRESS.

## Antenna Position Debug Tool:

The Antenna Position Debug Tool is used to test antenna RSSI values that will help you locate the optimal installation position of the outdoor antenna. Select your device, and right click to access a pop-up menu with additional options as shown below. Select Antenna Position Debug.

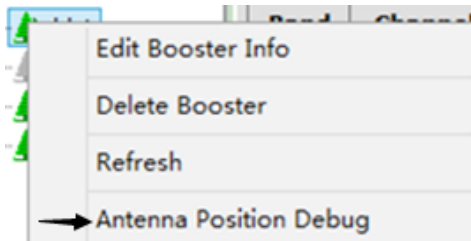

You will see the following Debug Tool screen:

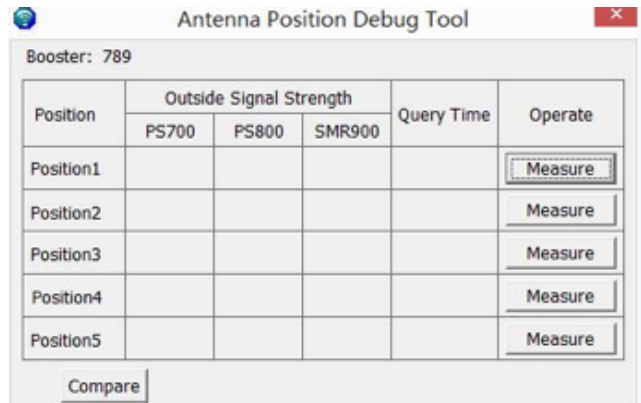

Antenna Position Debug Tool

Booster: 789

Position	Outside Signal Strength			Query Time	Operate
	PS700	PS800	SMR900		
Position1					Measure
Position2					Measure
Position3					Measure
Position4					Measure
Position5					Measure

Compare



# Sentry Configuration & Monitoring

---

Place the antenna in the appropriate position and click Measure to read the current RSSI value. Then try putting the antenna in 5 different positions, read their respective 5 RSSI values, and click Compare to get the best position. You can also use the reported RSSI values to determine the best position manually.

## Over Power Alert:

If Red=ON, it means the input signal is too strong, and can result in device shut-off. Here are four possible solutions you can try:

- Increase the attenuation
- Reposition the outdoor antenna
- Reduce the gain
- Manually adjust the attenuation or turn off a single band to mitigate oscillation and over-power issues.

# Safety and Compliance

---

## CHAPTER 8: SAFETY AND COMPLIANCE

---

### 8.1 FCC Compliance

This is a Class B device. The product has been tested and found to comply with the Booster Requirements per FCC Part 90.

### 8.2 A Word About Safety

Follow all safety precautions in this manual. This information is designed to prevent personal injury, equipment malfunction, and/or radio interference. You are responsible for ensuring a safe installation.

Your installation may require working in high locations such as roofs and/or ladders. Follow applicable safety regulations and best practices to avoid falling. Take care not to drop objects from any high area. Cordon off ground areas directly below the section of roof you are working on, or below your ladder whenever possible.

In addition, as a qualified installer, you are responsible for knowing and following all applicable codes and regulations and for obtaining all required permits and inspections.

Always use appropriate personal protective equipment such as goggles, gloves, hard hat, etc. as needed, and as required.



**WARNING: FAILURE TO EXERCISE CAUTION WHEN WORKING IN HIGH AREAS COULD CAUSE A FALL AND PERSONAL INJURY.**

**This is an in-building Part 90 Signal Booster. It is a 90.219 CLASS B device.**

### **WARNING**

This is NOT a CONSUMER device. It is designed for installation by FCC LICENSEES and QUALIFIED INSTALLERS.

You MUST have an FCC LICENSE or the express consent of an FCC Licensee to operate this device. You MUST register Class B signal boosters as defined by the FCC's CFR 90.219.

Unauthorized use may result in significant forfeiture penalties, including penalties in excess of \$100,000 for each continuing violation.

## CHAPTER 9: SPECIFICATIONS

Product Name	Guardian3 QR
Uplink Frequency Range (MHz):	788-805 / 806-824 / 896-901 (Including D Block)
Downlink Frequency Range(MHz):	758-775 / 851-869 / 935-940 (Including D Block)
Maximum Gain:	80 dB
Gain Adjustment:	31 dB
Noise Figure:	≤ 8 dB
VSWR:	≤ 2.0
Supported Standards:	Public Safety 700 and 800, and SMR 900
AC Input:	110 V, 60 Hz
Maximum RF Output Power:	26 dBm
P1dB:	31.5 dBm
Cable:	SC-400 (not provided)
RF Connectors:	N Female (both ends)
Power Consumption:	50W
Operating Temperature:	-4°F to +131°F
Dimensions:	21.5 x 17 x 6 inches
Weight:	49.6 lbs.
FCC (USA):	RSNFORCE3-PSB

## CHAPTER 10: WARRANTY

---

Activate your product warranty at [www.surecall.com](http://www.surecall.com)

For questions regarding your warranty, contact a SureCall representative at 1-888-365-6283 or email [support@surecall.com](mailto:support@surecall.com).

### 10.1 Warranty Periods

Your warranty includes the following periods:

- **Three-Year Product Warranty:** SureCall products are covered under a three-year product warranty from the date of purchase. This protects the customer from any defects or problems the product may have that are solely the fault of SureCall. Incorrect installation or misuse will void this warranty. Upon the return of a defective product, SureCall will issue the customer a working replacement. All returned packages should contain all products distributed.
- **Five-Year Extended Product Warranty:** A five year warranty is available for purchase on any products sold by SureCall. A five-year warranty must be obtained at the time of purchase. This warranty adds an additional two years to the three year warranty we provide. All regulations still apply.

### 10.2 Three-Year Product Warranty

SureCall warrants its products for three years from the date of purchase against defects in workmanship and/or materials. Specifications are subject to change. The three-year warranty only applies to products meeting the latest FCC Certification Guidelines stated on 2/20/2013 and going into effect April 30, 2014. A two-year warranty applies to any products manufactured before May 1, 2014.

Products returned by customers must be in their original, un-modified condition, shipped in the original or protective packaging with proof-of-purchase documentation enclosed, and a Return Merchandise Authorization (RMA) number printed clearly on the outside of the shipping container.

Buyers may obtain an RMA number for warranty returns by calling the SureCall Return Department toll-free at 1-888-365-6283. Any returns received by SureCall without an RMA number clearly printed on the outside of the shipping container will be returned to sender. In order to receive full credit for signal boosters, all accessories originally included in the signal booster box must be returned with the signal booster. (The Buyer does not need to include accessories sold in addition to the signal booster, such as antennas or cables.)

This warranty does not apply to any product determined by SureCall to have been subjected to misuse, abuse, neglect, or mishandling that alters or damages the product's physical or electronic properties.

SureCall warrants to the Buyer that each of its products, when shipped, will be free from defects in material and workmanship, and will perform in full accordance with applicable specifications. The limit of liability under this warranty is, at SureCall's option, to repair or replace any product or part thereof which was purchased up to **THREE YEARS after May 1, 2014 or TWO YEARS for products purchased before May 1, 2014**, as determined by examination by SureCall, prove defective in material and/or workmanship. Warranty returns must first be authorized in writing by SureCall. Disassembly of any SureCall product by anyone other than an authorized representative of SureCall voids this warranty in its entirety. SureCall reserves the right to make changes in any of its products without incurring any obligation to make the same changes on previously delivered products.

As a condition to the warranties provided for herein, the Buyer will prepay the shipping charges for all products returned to

SureCall for repair, and SureCall will pay the return shipping with the exception of products returned from outside the United States, in which case the Buyer will pay the shipping charges.

The Buyer will pay the cost of inspecting and testing any goods returned under the warranty or otherwise, which are found to meet the applicable specifications or which are not defective or not covered by this warranty.

Products sold by SureCall shall not be considered defective or non-conforming to the Buyer's order if they satisfactorily fulfill the performance requirements that were published in the product specification literature, or in accordance with samples provided by SureCall. This warranty shall not apply to any products or parts thereof which have been subject to accident, negligence, alteration, abuse, or misuse. SureCall makes no warranty whatsoever in respect to accessories or parts not supplied by it.

### **10.3 Limitations of Warranty, Damages and Liability**

EXCEPT AS EXPRESSLY SET FORTH HEREIN, THERE ARE NO WARRANTIES, CONDITIONS, GUARANTEES, OR REPRESENTATIONS AS TO MERCHANTABILITY, FITNESS FOR A PARTICULAR PURPOSE, OR OTHER WARRANTIES, CONDITIONS, GUARANTEES, OR REPRESENTATIONS, WHETHER EXPRESSED OR IMPLIED, IN LAW OR IN FACT, ORAL OR IN WRITING.

SURECALL AGGREGATE LIABILITY IN DAMAGES OR OTHERWISE SHALL NOT EXCEED THE PAYMENT, IF ANY, RECEIVED BY CELLPHONE-MATE, INC. FOR THE UNIT OF PRODUCT OR SERVICE FURNISHED OR TO BE FURNISHED, AS THE CASE MAY BE, WHICH IS THE SUBJECT OF CLAIM OR DISPUTE. IN NO EVENT SHALL SURECALL BE LIABLE FOR INCIDENTAL, CONSEQUENTIAL, OR SPECIAL DAMAGES, HOWSOEVER CAUSED.

All matters regarding this warranty shall be interpreted in accordance with the laws of the State of California, and any controversy that cannot be settled directly shall be settled by arbitration in California in accordance with the rules then prevailing of the American Arbitration Association, and judgment upon the award rendered may be entered in any court having jurisdiction thereof. If one or more provisions provided herein are held to be invalid or unenforceable under applicable law, then such provision shall be ineffective and excluded to the extent of such invalidity or unenforceability without affecting in any way the remaining provisions hereof.

**WARNING: E911 location information may not be provided or may be inaccurate for calls served BY USING THIS DEVICE.**

48346 Milmont Drive  
Fremont, California 94538, USA  
888.365.6283  
[www.surecall.com](http://www.surecall.com)

SureCall has made a good faith effort to ensure the accuracy of the information in this document and disclaims the implied warranties of merchantability and fitness for a particular purpose and makes no express warranties, except as may be stated in its written agreement with and for its customers. SureCall shall not be held liable to anyone for any indirect, special or consequential damages due to omissions or errors. The information and specifications in this document are subject to change without notice.

© 2017. All Rights Reserved. All trademarks and registered trademarks are the property of their respective owners.

SureCall, Inc  
48346 Milmont Drive  
Fremont, California 94538, USA  
888.365.6283 | [www.surecall.com](http://www.surecall.com)

Activate your warranty at [surecall.com/activate](http://surecall.com/activate)