

# PVC-RMI

## Intelligent Remote Mic

The PVC-RMI Remote Mic Interface is mounted in a remote cabinet. The PVC-RMI expands the ability to Page and control conventional PVX system functions from multiple remote locations. The PVC-RMI operates as the host for remote PVC-SL8 switch banks as well as the PVC-IL8 input and PVC-OL8 output interface cards. It communicates these functions to the system via the RS-485 interface.

The PVC-RMI has an address DIP switch which determines the device address on the RS-485 loop. This address switch is set between 1 and 31. A maximum of 31 RMI units may be wired together. SW1 is turned "on" at the last device to mark that device as the "end of line".

LED 1 is the Status LED. It flashes Green during normal standby condition to show that the device is operational. LED 1 will be Green steady when the Microphone PTT button is engaged and the unit is asserting the audio line. LED 1 will flash Amber to indicate a Fault condition on this device.

LED 2 is the In Use indicator. It will be Red steady when another device is asserting the audio line. The primary PVX 25/50/100 will always have highest priority. It will override any other PVC-RMI as long as its MIC PTT is activated. If there are multiple RMIs in the system, the first to activate its MIC PTT will assert the audio line. When its MIC PTT is released another may activate.

SL8 LEDs: On the Switch/LED card utilized with the PVC-RMI, LEDs will indicate Steady Red for Paging, Flashing Red for Alarm. MNS Messages will indicate Green on any associated Zone.

### Installation:

Installer must insure that all wiring and devices installed in system meet the following standards:  
National Electrical Code (NFPA 70) / NFPA Standard 72

Models: PVC-RM8 (8 switches) / PVC-RM16 (16 switches) Configurations with up to 128 switches available

Mounting: The PVC-RMI is intended to mount within the PVC-RM8/16 cabinet on stand-offs.  
For PVC-RM24 - PVC-RM128 mounting of components will be within a CAB102 with a windowed door.

**Fig. 1 - Board Layout**

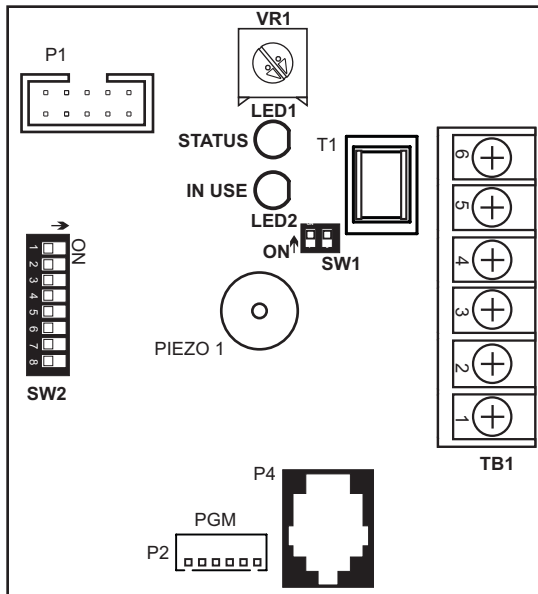

### LED1: Status

GREEN flash = device active  
GREEN solid = unit is asserting the audio line  
Amber Flash = fault

### LED2: In Use

Illuminated Red when audio line is being asserted by another active device

### SW1: EOL

SW1-1: "ON" to set as last device  
SW1-2: "ON" to set as last device

### SW2: 1-5 Address Switch

Set 1st device as "1", 2nd as "2", etc.  
See Page 4 for Addressing

**SW2:** 6-8 Do not Use  
Factory use only

### VR1: Mic Gain

Clockwise to increase

### TB1: Class B Style 4

TB1-1: Circuit Neg  
TB1-2: +24VDC  
TB1-3: Audio -  
TB1-4: Audio +  
TB1-5: RS 485 -  
TB1-6: RS 485 +

### P1: I2C Port Out

10 Pin Connector, out to PVC-SL8

### P2

programming port

### P4

microphone socket

### PIEZO1:

Sounds during fault condition

### SPECIFICATIONS

Power: VDC +24V

Current Draw: 12mA standby  
36.5mA active

The PVC-RMI current consumption is drawn from an PVC-100M. The current consumption of the RMI and the additional intelligent devices will increase that amplifiers battery draw.

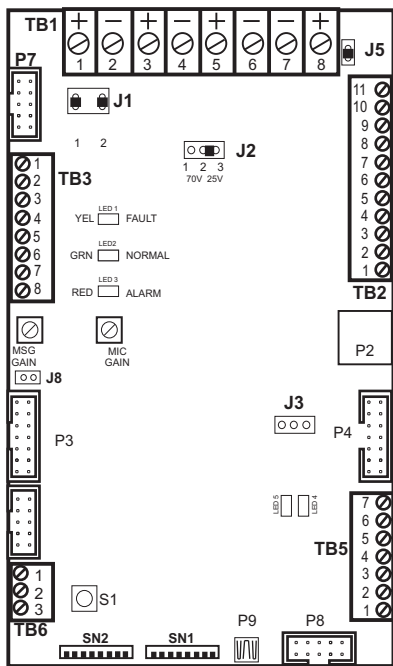

**Fig 2**  
Multiple PVC-RMI  
connection detail

**Alternate Power Connection:**

PVC-RMI may be powered separately by a 24VDC Power Supply Listed to UL2572 or UL1481. Power Supply must be mounted adjacent to PVX 25/50/100 and have Circuit Negative tied common to the PVX 25/50/100. 24VDC Power connects to PVC-RMI, not to the PVC-100M. All other connections remain the same. Power Supply must be tied to the same AC Branch circuit as the PVC-100M.

Supervised, Power Limited

6 conductors  
(Three pairs)  
See Wiring  
Guide on pg. 3

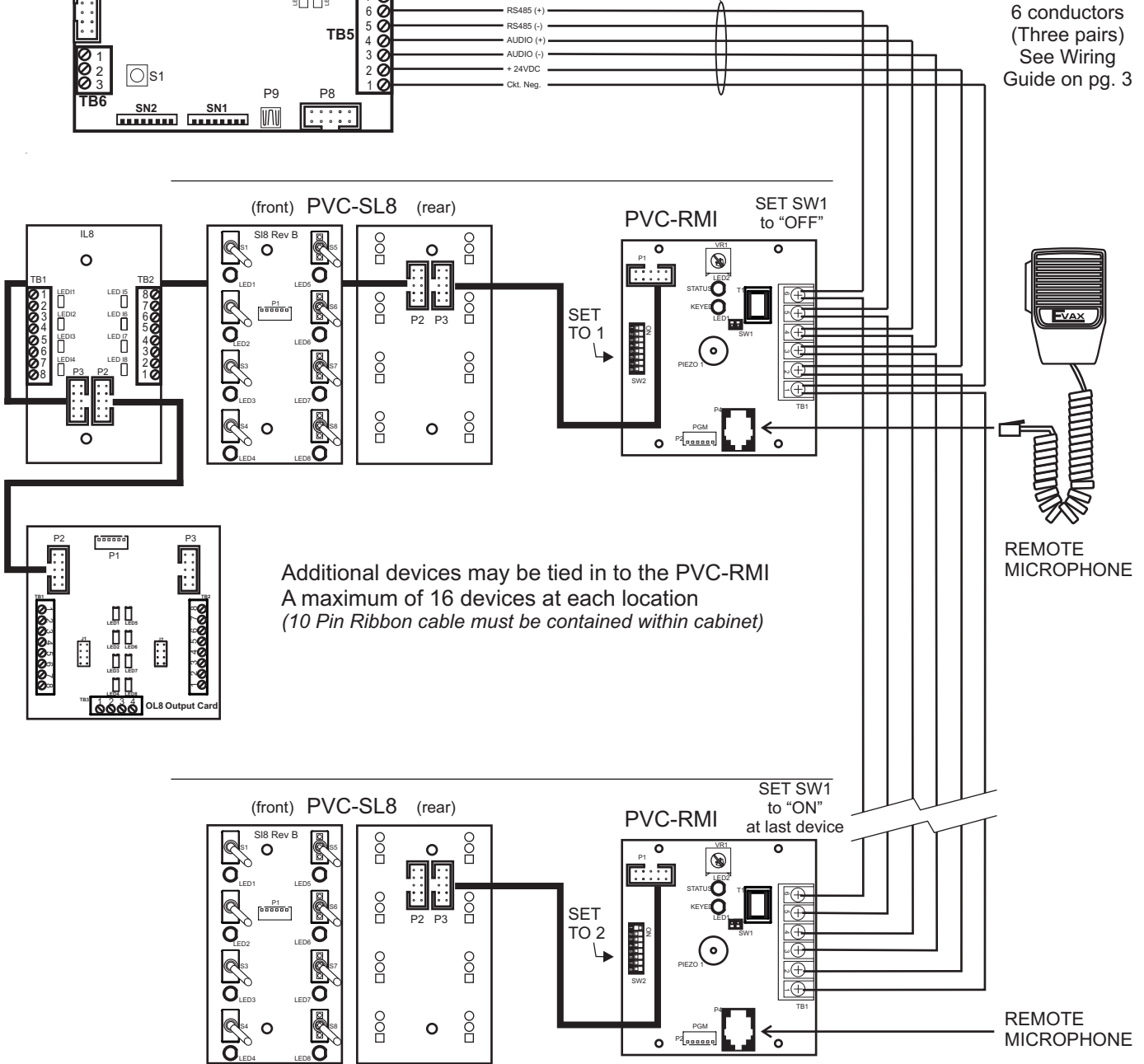

Additional devices may be tied in to the PVC-RMI  
A maximum of 16 devices at each location  
(10 Pin Ribbon cable must be contained within cabinet)

**\*NOTE**  
Maximum number of PVC-RMI  
units to be cascaded: 31

# PVC-100M

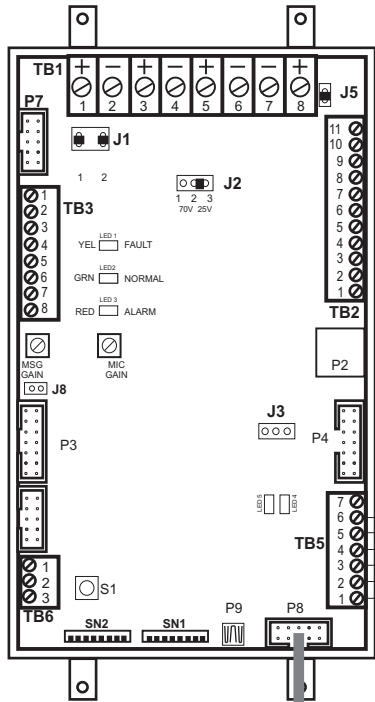

**Fig. 3**  
Typical connection from PVC-100M to PVC-SL8 and PVC-RMI

SL8 LEDs: On the Switch/LED card which may be utilized with either the PVC-100M or the PVC-RMI, Page Switch LEDs will indicate steady Red for Paging, flashing Red for Alarm. MNS Messages will indicate Green on any associated Zone. Any Zone in Fault will indicate Amber.

Switches used for Message activation will indicate Red for Alarm or Green for MNS Messages.

Switches used for Output activation will indicate Red.

6 conductors  
(Three pairs)  
SEE WIRING  
GUIDE BELOW

- RS485 (+)
- RS485 (-)
- AUDIO (+)
- AUDIO (-)
- + 24VDC
- Ckt Neg.

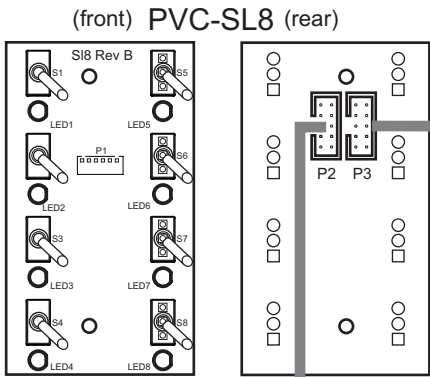
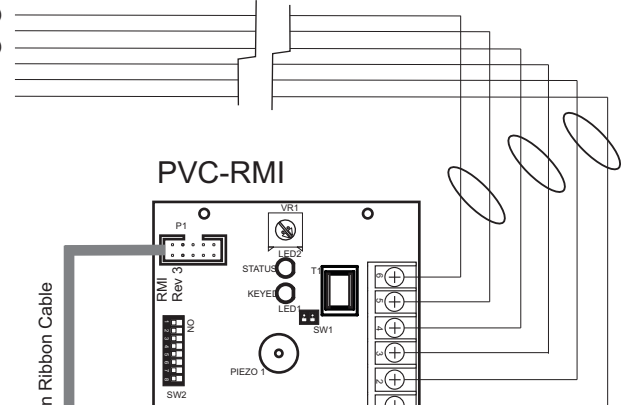

to additional  
PVC-SL8 units  
or other devices  
(\*max 16 units cascaded)

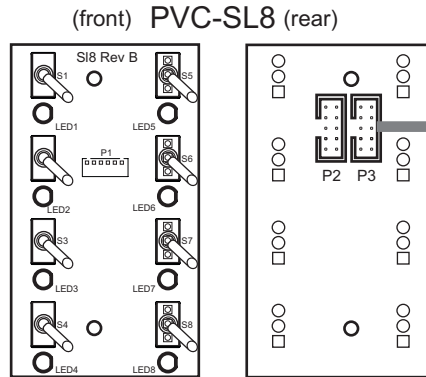











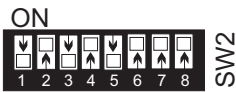

















## WIRING GUIDE

WIRE TYPE	MAX WIRE RESISTANCE	MAX WIRE CAPACITANCE	MAX WIRE LENGTH
22 AWG min. Twisted Pair	120 Ohms	.5uf	4000'

*Wire for 24 VDC pair must be sized to insure no more than a 20% drop in voltage at the last device*

# PVC-RMI

## PVC-RMI Addressable Switch Settings

1		11		21	
2		12		22	
3		13		23	
4		14		24	
5		15		25	
6		16		26	
7		17		27	
8		18		28	
9		19		29	
10		20		30	
				31	